



4601 Padre Blvd
South Padre Island, Texas 78597
www.MySPI.org

Invitation to Bid Construction Services

2021-PW02 LAGUNA BOULEVARD STREET AND DRAINAGE IMPROVEMENTS

Bids must be received before:
December 1, 2021
10:00 a.m. central time
City of South Padre Island
ATTN: City Secretary
4601 Padre Blvd.
South Padre Island, TX 78597



TABLE OF CONTENTS

INSTRUCTIONS to BIDDERS 3

BID TERMS and CONDITIONS 5

CONTRACTOR'S PROPOSAL 13

CONTRACTOR'S EXPERIENCE and QUALIFICATIONS 17

CERTIFICATION and ACKNOWLEDGMENT 19

GENERAL and SPECIAL CONDITIONS of AGREEMENT 20

STANDARD FORM of AGREEMENT for CONSTRUCTION 21

INSTRUCTIONS TO BIDDERS

Bids are solicited for **Laguna Boulevard Street and Drainage Improvements** with the following definitions, terms and conditions of bidding. This bid contains the City's standard contract terms, conditions and insurance requirements, attached as Exhibit A.

A. NOTICE

Sealed bids are due at 10:00 a.m. on **December 1, 2021** after which time all qualified bids will be opened and publicly read aloud at 4601 Padre Blvd, South Padre Island, Texas 78597. Bids received after the specified deadline will be returned unopened.

Sealed bids shall be clearly marked with the bid number and title and addressed to the City of South Padre Island – City Secretary. Bids shall be delivered using one of the following:

Hand-deliver to:	Mail to:	Ship to (FedEx, UPS, DHL):
4601 Padre Blvd South Padre Island, TX 78597	4601 Padre Blvd. South Padre Island, TX 78597	4601 Padre Blvd. South Padre Island, TX 78597

B. LOCATION AND DESCRIPTION OF PROJECT

Laguna Boulevard is located west of Padre Boulevard and entails reconstructing the street from Palm Street to Morningside Drive including drainage improvements and addition of a bicycle lane.

C. PRE-BID CONFERENCE

A Pre-bid Meeting will be held at City Hall, EOC Room, 4601 Padre Blvd, City of South Padre Island, Texas at **10:00 a.m.** central time on **November 9, 2021**. This meeting is not mandatory, but attendance is highly recommended.

D. COPIES OF BIDDING DOCUMENTS

A complete set of Bidding and Contract Documents will be made available for no charge on a flash drive (or other electronic means) at:

City of South Padre Island
Public Works Department
4601 Padre Blvd.
South Padre Island, TX 78597

Vendors may receive notice of bids from the City of South Padre Island from a variety of channels. Approved methods of dissemination include: City of South Padre Island website or the City of South Padre Island Public Works Department. The receipt of solicitations through any other means may result in the receipt of incomplete specifications or addenda which could ultimately render your bid non-compliant. City of South Padre Island accepts no responsibility for the receipt or notification of solicitations through any other source.

E. BID SECURITY

A Certified Cashier's Check or an acceptable Bid Bond in an amount of not less than five (5) percent of the total amount bid, shall accompany each bid proposal.

F. BONDS

The successful bidder will be required to furnish a Payment Bond and Performance Bond in the amount of the contract. Bidders may not withdraw their Bid Proposal within 60 calendar days of the bid opening date.

G. QUESTIONS and INQUIRIES

The deadline for written questions is **November 18, 2021 @ 2:00 p.m.** Questions and inquiries about this Solicitation shall be submitted in writing to the following individual:

C. Alejandro Sanchez, P.E., CFM.
Public Works Director
alexsanchez@myspi.org

H. SCHEDULE OF IMPORTANT DATES

The tentative schedule for this Solicitation is as follows:

Release ITB to Vendors	October 28, 2021
Advertisement Dates	October 28, 2021 & November 4, 2021
Deadline for Questions and Inquiries	November 18, 2021
ITB Due Date	December 1, 2021
Earliest Award by City	December 15, 2021

BID TERMS and CONDITIONS

A. DEFINITION OF TERMS

In order to simplify the language throughout this bid, the following definitions and those defined in the Contract Documents shall apply:

BIDDER - A contractor who submits a Bid directly to the City.

BIDDING DOCUMENTS - the Advertisement, Instructions to Bidders, Bid Terms and Conditions, the Proposal, Special Provisions, Technical Specifications and the proposed Contract Documents (including all Addenda issued prior to the receipt of Bids).

CITY OF SOUTH PADRE ISLAND – Same as City.

CITY COUNCIL – The elected officials of the City of South Padre Island, Texas given the authority to exercise such powers and jurisdiction of all City business as conferred by the State Constitution and Laws.

CONTRACT – An agreement between the City and a Supplier to furnish supplies and/or services over a designated period of time during which repeated purchases are made of the commodity specified.

CONTRACTOR – The successful Bidder(s) of this bid request.

CITY – The government of the City of South Padre Island, Texas.

OWNER – City of South Padre Island.

SUB-CONTRACTOR – Any contractor hired by the Contractor or Supplier to furnish materials and services specified in this bid request.

SUCCESSFUL BIDDER - the lowest, qualified, responsible and responsive Bidder to whom the City (on the basis of the City's evaluation as hereinafter provided) makes an award.

SUPPLIER – Same as Contractor.

B. PREBID CONFERENCE

A Pre-bid Meeting will be held at City Hall, EOC Room, 4601 Padre Blvd, South Padre Island, Texas at 10:00 a.m. central time on November 16, 2021. This meeting is not mandatory, but attendance is highly recommended.

Representatives of the Owner will be present to discuss the project. Bidders are highly encouraged to attend and participate in the conference. Owner's Representative will transmit to all prospective bidders of record such Addenda as he considers necessary in response to questions arising at the conference.

C. GENERAL BID PROVISIONS

1. The Invitation to Bid as advertised will be considered an inclusion of the specifications and conditions.
2. The term "Owner" as used throughout these documents will mean The City of South Padre Island, Texas.
3. Bid proposals will be submitted on the forms provided by Owner. All figures must be written in ink or typewritten. However, mistakes may be crossed out, corrections inserted adjacent thereto and initialed in ink by the person signing the proposal. Do not use a whiteout or other cover products on mistakes.
4. Formal advertised bids indicate date and time by which the bids must be received at the designated location. Bids received after that time will be returned unopened to the bidder.

5. The bidder will note any exceptions to the conditions of this bid. If no exceptions are stated, it will be understood that all general and specific conditions will be complied with, without exception.
6. Bidders may request withdrawal of a posted sealed proposal prior to the scheduled bid opening time, provided the request for withdrawal is submitted to the City of South Padre Island in writing. Owner reserves the right to reject any and all bids by reason of this request.
7. In the event there are inconsistencies between the general provisions and other bid terms or conditions contained herein, the former will take precedence.
8. If it becomes necessary to revise any part of this bid, a written addendum will be provided to all bidders. Owner is not bound by any oral representations, clarifications, or changes made in the written specifications by Owner's employees, unless such clarification of change is provided to bidders in written addendum form from the City of South Padre Island.
9. All bids will be awarded to the lowest responsible bidder. The determination of the lowest responsible bidder may involve all or some of the following factors: price, conformity to specifications, financial ability to perform the contract, previous performance, facilities and equipment, availability of repair parts, qualifications and experience, delivery promise, payment terms, compatibility as required, other costs, and other objectives and accountable factors which are reasonable.
10. Owner may give an environmental preference to products or services that have a lesser or reduced effect on human health and the environment when compared with competing products and services that serve the same purpose. This comparison may consider raw materials acquisition, product, manufacturing, packaging, distribution, reuse, operation, maintenance, or disposal of the product or service;
11. Bidders may be disqualified and rejection of proposals may be recommended to the Owner for any (but not limited to) of the following causes: 1) Failure to use the proposal form furnished by the Owner; 2) Lack of signature by an authorized representative on the proposal form; 3) Failure to properly complete the proposal; 4) Evidence of collusion among proposers; 5) Omission of a certified Cashiers Check or Bid Bond (if required) proposal guarantee; 6) Unauthorized alteration of bid form; 7) Lack of appropriate qualifications and experience relative to the size and scope of the work proposed; 8) Unsatisfactory performance; 9) Failure to complete projects or 10) Loaded or unbalanced bids. Owner reserved the right to waive any minor informality or irregularity.
12. Whenever in this invitation, any particular materials, process and/or equipment are indicated or specified by patent, proprietary or brand name, or by name of manufacture, such wording will be deemed to be used for the purpose of facilitating description of the material, process and/or equipment desired and will be deemed to be followed by the words "or equal." Contractor shall provide exactly such items in his bid as described, unless approved pursuant to other provisions provided herein.
13. Samples of items shall be furnished, if requested by the Owner, without charge, and if not destroyed, shall be returned upon request at the bidder's expense.
14. It is agreed that the successful bidder will not assign, transfer, convey or otherwise dispose of the contract or its right, title or interest in or to the same, or any part thereof, without previous written consent of Owner and any sureties.
15. Contractor must provide audited financial statements, if requested, to the City.
16. Prices in the Bid Proposal shall be presented in the format requested (Unit Price, Lump Sum, etc.)
17. No freight or delivery charges will be accepted unless shown on bid.
18. Owner is exempt from State Retail Tax and Federal Excise Tax. The price bid must be net, exclusive of taxes.

19. All bidders will comply with all Federal, State, and local laws relative to conducting business in the City of South Padre Island. The laws of the State of Texas will govern as to the interpretation, validity, and effect of this bid, its award and any contract entered into.
20. The successful bidder agrees by entering into this contract, to defend, indemnify and hold Owner harmless from any and all causes of action or claims of damages arising out of or related to bidder's performance under this contract.
21. Advanced disclosures of any information to any particular bidder which gives that particular bidder any advantage over any other interested bidder in advance of the opening of bids, whether in response to advertising or an informal request for bids, made or permitted by a member of the governing body or an employee or representative thereof, will operate to void all proposals of that particular bid solicitation or request.
22. Minority business enterprises will be afforded full opportunity to submit bids in response to this invitation and will not be discriminated against on the grounds of race, color, creed, sex, or national origin in consideration for an award.

D. QUALIFICATIONS OF BIDDERS

To demonstrate qualifications to perform the Work, each Bidder must be prepared to submit within five days of City's request, written evidence, such as financial data, previous experience, present commitments and other such data as may be called for below. Each Bid must contain evidence of the Bidder's qualifications to do business in the State of Texas or covenant to obtain such qualification prior to award of the contract.

In determining a bidder's qualifications, the following factors will be considered:

1. Work previously completed by the bidder and whether the bidder:
 - a. maintains a permanent place of business,
 - b. has adequate plant and equipment to do the work properly and expeditiously,
 - c. has paid or settled all claims for payment promptly,
 - d. has appropriate technical experience,
 - e. has job references for work of similar size and scope to the project bid herein; and
 - f. satisfactory performance and completion of public, or comparable, projects.
2. The safety record of the Bidder, of the corporation, partnership, or institution represented by the Bidder, or of any one acting for such firm, corporation, or partnership.

Each Bidder may be required to show that he has properly completed similar type work and that no claims are now pending against such work. No bid will be accepted from any bidder who is engaged in any work that would impair his ability to fully execute, perform or finance this work.

The General/Sub-Contractors Experience Data Sheet following the proposal must be filled out and submitted with the bid for consideration. Failure to include a completed Data Sheet may result in the rejection of the bid.

E. EXAMINATION OF CONTRACT DOCUMENTS AND SITE

1. It is the responsibility of each Bidder before submitting a Bid, to:
 - a. examine the Contract Documents thoroughly,
 - b. visit the site to become familiar with local conditions that may affect cost, progress, performance or furnishing of the Work,
 - c. consider federal, state and local Laws and Regulations that may affect cost, progress, performance or furnishing of the Work,
 - d. study and carefully correlate Bidder's observations with the Contract Documents, and

- e. notify Owner's Representative of all conflicts, errors or discrepancies in the Contract Documents.
 - f. visit with local utilities, including cable companies, and other entities that may have underground or above-ground infrastructure in the work area for infrastructure location.
2. Information and data reflected in the Contract Documents with respect to underground facilities at or contiguous to the site is based upon information and data from the Owner's files for its underground facilities and information and data furnished by owners of other underground facilities. Owner does not assume responsibility for the accuracy or completeness thereof.
 3. Before submitting a Bid each Bidder will be responsible to make or obtain such explorations, at bidders expense and not to be added into cost of bid if accepted (tests and data concerning physical conditions - surface, subsurface and underground facilities - at or contiguous to the site, or otherwise) which may affect cost, progress, performance or furnishing of the Work and which Bidder deems necessary to determine its Bid for performing and furnishing the Work in accordance with the time, price and other terms and conditions of the Contract Documents.
 4. The lands upon which the Work is to be performed, rights-of-way and easements for access thereto and other lands designated for use by Contractor in performing the Work are identified in the Contract Documents. All additional lands and access thereto required for temporary construction facilities or storage of materials and equipment or disposal of spoil are to be provided by Contractor. Contractor is responsible for obtaining all permits required for any of the before mentioned purposes prior to beginning work in accordance with the Standard Form Of Agreement, Paragraph 35 Permits and Licenses.
 5. The submission of a Bid will constitute an incontrovertible representation by Bidder that Bidder has complied with every requirement of this section, that without exception the Bid is premised upon performing and furnishing the Work required by the Contract Documents and such means, methods, techniques, sequences or procedures of construction as may be indicated in or required by the Contract Documents, and that the Contract Documents are sufficient in scope and detail to indicate and convey understanding of all terms and conditions for performance and furnishing of the Work. No pleas of ignorance of conditions that may be encountered in their execution of the Work under this contract, that is a result of failure to make the necessary examinations and investigations herein above indicated, will be accepted as an excuse for the failure or omission on the part of the Contractor to fulfill in every detail all the requirements of the Contract Documents. In no event shall a claim for extra compensation or for an extension of time be allowed for failure to thoroughly examine all requirements of Contract Documents.

F. INTERPRETATIONS and ADDENDA

All questions about the meaning or intent of the Contract Documents are to be directed to the Owner. Interpretations or clarification considered necessary by Owner's Representative in response to such questions will be issued by Addenda and mailed or otherwise delivered to all parties recorded by Owner's Representative as having received the Bidding Documents. Questions received less than 48 hours prior to opening of Bids will not be answered. Only questions answered by a formal written Addenda will be binding. No oral and other interpretations or clarification will be considered official or binding.

Addenda may also be issued to modify the Bidding Documents as deemed advisable by the City.

To properly qualify his bid, each Bidder shall, prior to filing his Bid, check the receipt of all Addenda or letters of clarification issued and acknowledge such receipt on the Proposal Form or on a separate attachment to the bid. Bids without such acknowledgment of all issued Addenda and letters of

clarification may cause your bid to be considered non-responsive. Such Addenda and letters of clarification shall become a part of the executed contract and modify the contract documents accordingly.

G. BID SECURITY

Bidders must submit with their Bids a Cashier's Check or a Certified Check in the amount of five (5%) percent of the maximum amount of Bid payable without recourse to the City of South Padre Island, Texas, or a bid bond in the same amount from a surety company holding permit from the State of Texas to act as a surety, as a guarantee that Bidder will enter into a contract and execute bond and guarantee forms within fifteen (15) days after notice of award of contract. Bids without checks, as stated above, or acceptable bid bond may not be considered.

Bid Security shall be in effect from the opening of the Bid and will be retained until a Bidder has executed the Agreement and furnished the required contract security, whereupon the Bid Security will be returned. A Bidder may withdraw its Bid at any time until the Agreement is signed. However, it will forfeit its Bid Security in doing so if no material mistake was made in the Bid.

The Bid Security of the Successful Bidder will be retained until such Bidder has executed the Agreement and furnished the required contract security, whereupon the Bid Security will be returned. If the Successful Bidder fails to execute and deliver the Agreement and furnish the required contract security within fifteen (15) days after the Notice of Award, Owner may annul the Notice of Award and the Bid Security of that Bidder will be forfeited. The Bid Security of other Bidders whom Owner believes to have a reasonable chance of receiving the award may be retained by Owner until 5 days after the Agreement is executed whereupon Bid Security furnished by such Bidders will be returned. Bid Security with Bids which are not competitive will be returned within seven days after the Bid opening.

H. CONTRACT TIME

The times for Substantial Completion and Final Completion are set forth in the Special Provisions and will be included in the Standard Form of Agreement. It will be necessary for the Successful Bidder to satisfy the City of the Bidder's ability to achieve Substantial Completion and Final Completion within the times designated in the Special Provisions.

I. LIQUIDATED DAMAGES

TIME IS OF THE ESSENCE IN THIS CONTRACT. Failure to meet Substantial or Final Completion dates will result in damages to the city in an amount specified in City's Standard Form of Agreement.

J. SUBSTITUTE OR "OR EQUAL" ITEMS

The materials and equipment described in the Bidding Documents establish a standard of required function, dimension, appearance and quality to be met by any proposed substitution. No substitution will be considered unless written request for approval has been submitted by the Bidder and has been received by Owner's Representative at least five (5) working days prior to the date for receipt of Bids or until after the contract for the work has been signed. Each such request shall include the name of the material or equipment for which it is to be substituted and a complete description of the proposed substitute including drawings, cuts, performance and test data and any other information necessary for an evaluation. A statement setting forth any changes in other materials, equipment or work that incorporation of the substitute would require shall be included. The burden of proof of the merit of the proposed substitute is upon the Bidder. The Owner's Representative's decision of approval or disapproval of a proposed substitution shall be final. If Owner's Representative approves any proposed substitution before the date for receipt of bids, such approval will be set forth in an

Addendum issued to all prospective Bidders. Bidders shall not rely upon approvals made in any other manner.

K. BID FORM

All blanks on the Bid Form must be completed in ink or by typewriter. Unfilled blanks may result in the bid being disqualified.

Any financial amounts written in words will supersede amounts written by numbers in the Bid Form.

Bids by corporations must be executed in the corporate name by the corporate officer authorized to sign for the corporation, accompanied by evidence of authority to sign. The corporate address and state of incorporation must be shown below the signature.

Bids by partnerships must be executed in the partnership name and signed by a partner, whose title must appear under the signature and accompanied by evidence of authority to sign. The fiscal address of the partnership must be shown below the signature.

All names must be typed or printed below the signature.

The Bid shall contain an acknowledgment of receipt of all Addenda. The numbers and dates of which must be filled in on the Bid Form or on a separate attachment to the Bid.

The address and telephone number(s) for communication regarding the Bid must be shown.

All of the data on the GENERAL/SUB-CONTRACTORS EXPERIENCE AND DATA INFORMATION sheet must be completely filled in.

L. SUBMISSION OF BIDS

A Bid shall be submitted at the time and place indicated in the Advertisement. It shall be enclosed in an opaque sealed envelope, marked with the project title, name and address of the Bidder. The Bid shall be accompanied by the Bid Security and other required documents. If the Bid is sent through the mail or other delivery system the sealed envelope shall be enclosed in a separate envelope with the notation "BID ENCLOSED" on the face of it.

Each Bidder should, prior to filing his Bid check the receipt of all Addenda or letters of clarification issued and acknowledge such receipt on the outside of the envelope containing his Bid proposal.

M. MODIFICATION AND WITHDRAWAL OF BIDS

Bids may be modified or withdrawn by an appropriate document duly executed, in the described manner that a Bid must be executed and delivered to the place where Bids are to be submitted at any time prior to the opening of Bids.

If prior to the award of the contract by the City Council, any Bidder files a duly signed, written notice with Owner's Representative and promptly thereafter demonstrates to the reasonable satisfaction of Owner's Representative that there was a material mistake in the preparation of his Bid, that Bidder may withdraw his Bid and the Bid Security will be returned. Thereafter, that Bidder will be disqualified from further bidding on the Work to be provided under the Contract Documents.

N. OPENING OF BIDS

Properly prepared Bids will be opened publicly and read aloud. A summary of the amounts of the base Bids and major alternates (if any) will be made available to Bidders after the opening of Bids. A tabulation of the Bids which are read will be available upon request as soon as it has been assembled and verified.

Bids received after the specified time of the opening will be returned unopened.

O. BIDS TO REMAIN SUBJECT TO ACCEPTANCE

All bids will remain subject to acceptance, for 60 days after the date of the Bid opening, but Owner may, in its sole discretion, release any Bid and return the Bid Security prior to that date.

P. AWARD OF CONTRACT

Owner reserves the right to reject any and all Bids, to waive any and all informalities and irregularities not involving price, time, or changes in the Work and to disregard all non-conforming, non-responsive, unbalanced or conditional Bids. Owner reserves the right to reject the Bid of any Bidder if Owner believes that it would not be in the best interest of the Project to make an award to that Bidder, whether because the Bid is not responsive or the Bidder is unqualified or of doubtful financial ability or fails to meet any other pertinent standard or criteria established by Owner. Discrepancies in the multiplication of units of Work and unit prices will be resolved in favor of the unit prices. Discrepancies between the indicated sum of any column of figures and the correct sum thereof will be resolved in favor of the correct sum.

In evaluating Bids, Owner will consider the qualifications of the Bidders, whether or not the Bids comply with the prescribed requirements, time of construction, and such alternates, unit prices and other data, as may be requested in the Bid Form or prior to the Notice of Award.

Owner may consider the qualifications and experience of subcontractors, suppliers, and other persons and organizations proposed for those portions of the Work as to which the identity of subcontractors, suppliers, and other persons and organizations must be submitted as provided. Owner may also consider the operating costs, maintenance requirements, performance data and guarantees of major items of materials and equipment proposed for incorporation in the Work when such data is required to be submitted prior to the Notice of Award.

Owner may conduct such investigations as Owner deems necessary to assist in the evaluation of any Bid and to establish the responsibility, qualifications and financial ability of Bidders, proposed subcontractors, suppliers and other persons and organizations to perform and furnish the Work in accordance with the Contract Documents to Owner's satisfaction within the prescribed time.

If the contract is to be awarded, it will be awarded to the lowest responsible Bidder whose evaluation by Owner indicates to Owner that the award will be in the best interests of the Project.

If the contract is to be awarded, Owner will give the Successful Bidder a Notice of Award within 60 days after the day of the Bid opening.

Bid prices may be compared after adjusting for differences in the time designated in the Bid for Substantial Completion. The adjusting amount will be determined at the rate set forth in the Standard Form of Agreement for liquidated damages indicated for Substantial Completion for each day after the desired date appearing in City's Standard Form of Agreement.

Q. CONTRACT SECURITY

BOND PROVISIONS of the Standard Form of Agreement set forth Owner's requirements as to performance and payment Bonds. When the Successful Bidder delivers the executed Agreement to Owner, it must be accompanied by the required performance and payment Bonds.

R. SIGNING OF AGREEMENT

The Successful Bidder shall execute the Contract and provide proof of insurance as detailed in the Standard Form of Agreement based on Staff recommendation prior to Council action. No later than 15 days of Award, all required Bonds shall be delivered to Owner. A fully executed contract will be presented to Successful Bidder.

S. PERSONAL INTEREST

No employee or City Council Member of the City may have any financial interest, directly or indirectly, in any proposed or existing agreement, purchase, work, sale or service to, for, with or by the City.

T. DISCLOSURE OF INTERESTED PARTIES

Contracting hereunder may require compliance with §2252.908 Texas Government Code/Disclosure of Interested Parties for contracts that (1) require an action or vote by the City Council before the contract may be signed; or (2) has a value of at least \$1 million. The law provides that a governmental entity may not enter into certain contracts with a business entity unless the business entity submits a disclosure of interested parties to the governmental entity at the time the business entity submits the signed contract to the governmental entity or state agency.

For purposes of this section, the following definitions apply:

"Interested party" means a person who has a controlling interest in a business entity with whom the City contracts or who actively participates in facilitating the contract or negotiating the terms of the contract, including a broker intermediary, advisor, or attorney for the business entity.

"Controlling interest" means: (1) an ownership interest or participating interest in a business entity by virtue of units, percentage, shares, stock, or otherwise that exceeds 10 percent; (2) membership on the board of directors or other governing body of a business entity of which the board or other governing body is composed of not more than 10 members; or (3) service as an officer of a business entity that has four or fewer officers, or service as one of the four officers most highly compensated by a business entity that has more than four officers.

"Intermediary," means a person who actively participates in the facilitation of the contract or negotiating the contract, including a broker, adviser, attorney, or representative of or agent for the business entity who:

1. Receives compensation from the business entity for the person's participation;
2. Communicates directly with the City on behalf of the business entity regarding the contract; and
3. Is not an employee of the business entity.

The process as implemented by the Texas Ethics Commission ("TEC") is as follows:

1. The disclosure of interested parties must be performed using the [Texas Ethics Commission's electronic filing application](#) listing each interested party of which the business entity is aware on Form 1295, obtaining a certification of filing number for this form from the TEC, and printing a copy of it to submit to the City.
2. The copy of Form 1295 submitted to the City must be notarized and contain the unique certification number from the TEC. The form must be filed with the City pursuant to §2252.908 Texas Government Code, "at the time the business entity submits the signed contract" to the City.

The City, in turn, will submit a copy of the disclosure form to the TEC not later than the 30th day after the date the City receives the disclosure of interested parties from the business entity.

CONTRACTOR'S PROPOSAL

ITEM NO.	DESCRIPTION	EST. QTY.	UNIT	UNIT PRICE	TOTAL PRICE
BASE BID					
REMOVALS & ADJUSTMENTS					
1	RELOCATE TREES	19	EA		
2	REMOVE INLETS & MANHOLES	40	EA		
3	REMOVE 6" PVC	296	LF		
4	REMOVE 10" PVC	50	LF		
5	REMOVE 12" RCP	746	LF		
6	REMOVE 15" RCP	32	LF		
7	REMOVE 18" RCP	480	LF		
8	REMOVE 24" RCP	254	LF		
9	REMOVE SIDEWALK	16	SY		
10	REMOVE HANDICAP RAMP	1,137	SY		
11	REMOVE CONC. DRIVEWAYS	1,281	SY		
12	REMOVE ASPHALT DRIVEWAYS	996	SY		
13	REMOVE CURB & GUTTER	186	LF		
14	REMOVE ASPHALT PAVEMENT	116	SY		
15	REMOVE VALLEY GUTTER	310	SY		
16	REMOVE BUSHES	30	LF		
17	RELOCATE FENCE	120	LF		
18	REMOVE RIP RAP	1	LS		
19	RELOCATE WATER METER	1	EA		
20	ADJUST WATER VALVE	9	EA		
21	ADJUST AT&T MANHOLES	5	EA		
STREET					
22	2"-1/4 HMAC	34,285	SY		
23	PRIME COAT/ MC-30 (0.2 GAL/SY)	6,857	GAL		
24	3" LIMESTONE BASE	3,706	SY		
25	6" LIMESTONE BASE	34,285	SY		
26	8" SUBGRADE MATERIAL	43,705	SY		
27	4% CEMENT	670.0	TON		
28	CURB & GUTTER	11,523	LF		
29	VALLEY GUTTER	3,951	SF		
30	6" CONCRETE INTERSECTIONS	4,089	SY		
31	ASPHALT STREET TIE-IN	1,354	SY		
32	ASPHALT DRIVEWAY	752	SY		
33	CONCRETE DRIVEWAY	851	SY		
34	ADJUST SANITARY MANHOLE W/ CONCRETE COLLAR	40	EA		

ITEM NO.	DESCRIPTION	EST. QTY.	UNIT	UNIT PRICE	TOTAL PRICE
35	HANDICAP RAMP (TYPE 2)	3	EA		
36	HANDICAP RAMP (TYPE 5)	55	EA		
37	SIDEWALK	174	SY		
38	4' RETAINING WALL	220	LF		
DRAINAGE					
39	CURB INLET TYPE A	57	EA		
40	CURB INLET TYPE A-1 (5'x4')	4	EA		
41	CURB INLET TYPE A-2 (5'x5')	17	EA		
42	CURB INLET TYPE A-3 (5'x6')	11	EA		
43	CURB INLET TYPE A-4 (6'x6')	2	EA		
44	GRATE INLET TYPE C (3'x3')	6	EA		
45	GRATE INLET TYPE CC (5'x3')	6	EA		
46	GRATE INLET (5'x5')	1	EA		
47	GRATE INLET (6'x6')	1	EA		
48	H2O GRATES (BICYCLE PROOF)	3	EA		
49	MANHOLE - 48"	9	EA		
50	MANHOLE - 60"	2	EA		
51	MANHOLE - 72"	4	EA		
52	18" RCP	4,090	LF		
53	24" RCP	1,696	LF		
54	30" RCP	184	LF		
55	2'x3' BOX CULVERT	120	LF		
56	HEADWALL	60	LF		
57	RETAINING WALL	70	LF		
58	TRAFFIC RAILING (TYPE T1F)	130	LF		
59	WATERLINE ADJUSTMENTS	13	EA		
60	SEWER CONFLICT BOX(48" MANHOLE W/ CASING)	6	EA		
STORMWATER EROSION CONTROL MEASURES					
61	INSTALL CONSTRUCTION ENTRANCE	2	EA		
62	REMOVE CONSTRUCTION ENTRANCE	2	EA		
63	INSTALL SILT FENCE	4,400	LF		
64	REMOVE SILT FENCE	4,400	LF		
65	DUST CONTROL	11,114	LF		
MISCELLANEOUS ITEMS					
66	MOBILIZATION	1	LS		
67	BARRICADES, SIGNS & TRAFFIC HANDLING	24	MO		
68	6" PVC CONDUIT (SCH-40)	1,320	LF		
				BASE BID TOTAL	

ITEM NO.	DESCRIPTION	EST. QTY.	UNIT	UNIT PRICE	TOTAL PRICE
ADD ALTERNATIVE NO. 1					
LANDSCAPING					
1	SYLVESTER PALM TREES (10')	94	EA		
2	PLANTS (3 GAL.) - PADRE MIST	1,000	EA		
3	PLANTS - GULF COAST MUHLY (3 GAL.)	1,000	EA		
4	PLANTS (3 GAL.) - BEACH MORNING GLORY	1,000	EA		
5	PLANTS (3 GAL.) - MEXICAN FEATHERGRASS	1,000	EA		
6	FLORATAM GRASS	18,926	SF		
7	TOP SOIL	135	CY		
8	VEGETATIVE WATERING	9.20	MG		
PAVEMENT MARKING & SIGNAGE					
9	4" PAVEMENT MARKING (YELLOW)	3,822	LF		
10	4" PAVEMENT MARKING (WHITE)	9,401	LF		
11	4" PAVEMENT MARKING (GREEN)	9,401	LF		
12	6" PAVEMENT MARKING (WHITE)	1,000	LF		
13	12" PAVEMENT MARKING (WHITE)	2,150	LF		
14	24" PAVEMENT MARKING (WHITE)	682	LF		
15	24" PAVEMENT MARKING (GREEN)	2,259	LF		
16	PAVEMENT MARKING BIKE (SYMBOL)	120	EA		
17	RAISED REFLECTIVE MARKER (DOUBLE-WHITE)	70	EA		
18	RAISED REFLECTIVE MARKER (DOUBLE - GREEN)	2,130	EA		
19	STAMPED THERMOPLASTIC PAVEMENT MARKING	964	SF		
20	BIKE LANE SEPARATORS	805	EA		
21	SIGN RELOCATION/REPLACEMENT	66	EA		
LOW IMPACT DEVELOPMENT					
22	BIOSWALE/RAIN GARDEN	7,788	SF		
23	TREE WELL 5'x6'	94	EA		
ADD ALTERNATIVE NO. 1 TOTAL					

Note: Landscaping and Low Impact Development quantities are subject to change.

Provide all necessary labor, materials, and supplies for the construction of Laguna Boulevard Street and Drainage Improvements.

TOTAL BASE BID \$ _____
TOTAL ADD ALTERANTIVE NO. 1 BID \$ _____
TOTAL BID \$ _____

TOTAL number of calendar days to substantial completion _____

BY: _____
Signature *Date*

Printed Name *Title*

COMPANY: _____

Address: _____

Phone: _____

CONTRACTOR'S EXPERIENCE and QUALIFICATIONS

Name of Company: _____

Company Years in Business: _____

**List Municipal Projects
(Similar Projects in Size and Scope Completed in Last Five Years)**

Project	Municipality	\$ Amount	Type	Date

Superintendent & Project Manager Information

Include Superintendent proposed for the project, years of experience as superintendent, project manager proposed for the project, and years experience as project manager

Superintendent	Years Experience	Projects

Project Manager	Years Experience	Projects

References

Name 5 projects of similar work, giving owner's name, representative's name, project engineer's name, and telephone numbers for each

1.

<hr/>	<hr/>
<hr/>	<hr/>
<hr/>	<hr/>
<hr/>	<hr/>

2.

<hr/>	<hr/>
<hr/>	<hr/>
<hr/>	<hr/>
<hr/>	<hr/>

3.

<hr/>	<hr/>
<hr/>	<hr/>
<hr/>	<hr/>
<hr/>	<hr/>

4.

<hr/>	<hr/>
<hr/>	<hr/>
<hr/>	<hr/>
<hr/>	<hr/>

5.

<hr/>	<hr/>
<hr/>	<hr/>
<hr/>	<hr/>
<hr/>	<hr/>

CERTIFICATION and ACKNOWLEDGMENT

The undersigned affirms that they are duly authorized to submit this bid, that this bid has not been prepared in collusion with any other bidder, and that the contents of this bid have not been communicated to any other bidder prior to the official opening of this bid. To the extent this Contract is considered a Contract for goods or services subject to § 2270.002 Texas Government Code, Bidder certifies that it: i) does not boycott Israel; and ii) will not boycott Israel during the term of the Agreement. Additionally, the undersigned affirms that the firm is willing to sign the enclosed Standard Form of Agreement (if applicable).

Signed By: _____ Title: _____

Typed Name: _____ Company Name: _____

Phone No: _____ Fax No: _____

Email: _____

Bid Address: _____
P.O. Box or Street City State Zip

Remit Address: _____
P.O. Box or Street City State Zip

Federal Tax ID No: _____

DUNS No: _____

Date: _____

GENERAL and SPECIAL CONDITIONS OF AGREEMENT

A. GENERAL CONDITIONS OF AGREEMENT

The Standard Form of Agreement between Owner and Contractor shall be governing conditions of this contract.

1. STANDARD SPECIFICATIONS FOR CONSTRUCTION--CITY OF SOUTH PADRE ISLAND

CIVIL CONSTRUCTION: These specifications shall be used in conjunction with the City of South Padre Island's Standard Specifications of Water and Sewer Construction and Street Construction and is hereby incorporated by reference and those specifically provided for in Chapter 23 of the Code of Ordinances, City of South Padre Island. All City of South Padre codes and ordinances shall apply.

Any discrepancies between the City standards and these specifications shall be clarified per the instructions in Paragraph 9.0, "INTERPRETATIONS AND ADDENDA" in the instructions to Bidders.

B. SPECIAL CONDITIONS OF AGREEMENT

1. MEASUREMENTS: All work not specifically set forth as a pay item in the Proposal shall be considered a subsidiary obligation of the Contractor and all costs in connection therewith shall be included in the various unit prices listed in the Proposal.
2. QUANTITIES: Where unit quantities are shown on each bid item of the Proposal, they shall be construed to represent approximate quantities of Work to be completed. Final quantities will be determined by measurement on the site of the completed Work. Work performed outside of specified limits will not be included in final measurement. Bidders are hereby notified that no incidental items of the Work will be paid for unless it is listed in the Proposal form as a pay item.
3. EXPLOSION, COLLAPSE AND UNDERGROUND HAZARDS (XCU): Contracts where trenching depths exceed twelve (12) feet shall require additional coverage for the following General Liability hazards:

<u>Explosion</u>	Applies to blasting operations
<u>Collapse</u>	Applies to excavation and grading work adjacent to structure
<u>Underground</u>	Applies to excavation, burrowing, trenching, tunneling, etc. For example, severing an electrical line during excavation operations.

An additional premium may be assessed by contractor's insurance provider. Successful contractor is responsible for assessing depth based on plans and specifications contained herein.

4. TRAFFIC CONTROL. When work is performed in or immediately adjacent to a public street right-of-way, the Contractor shall submit to the City Engineer a traffic control plan for each public right-of-way he enters prior to the pre-construction meeting. This plan shall be in conformance to the Texas Manual on Uniform Traffic Control Devices. Once reviewed, the plans will be returned to the Contractor with comments.

Approved Traffic Control Plans shall be in the possession of the contractor on site during all work within the designated right of way.

5. MATERIAL STAGING. Contractor is responsible for identifying and securing a suitable site for the storage of materials and other construction related items unless such a site is specifically identified in the plans.
6. PERMITS. Contractor will be required to get permits pursuant to contract documents; however, city will waive the fees.
7. STORMWATER PERMIT. For construction areas disturbing more than one (1) acre of land, Contractor shall provide a Storm Water Pollution Prevention Plan and all related inspections, rain gages, signage, subsidiary to the contract.
8. SURVEY. The Owner will provide a one-time survey staking of key construction points, bench marks, horizontal controls, building corners, or utility appurtenances as deemed necessary by the City Engineer. Additional construction staking, or replacement staking, will be at the contractor's expense.
9. CONTRACTOR PARKING and BATHROOMS. Unless noted otherwise in the bid documents and plans, the installation of temporary bathroom facilities on the site will not be allowed. Parking for construction related vehicles, worker vehicles, and other equipment may be limited at the construction site. The Contractor should anticipate the need to provide for off-site parking subsidiary to the bid price in the contract.
10. FIELD OFFICES. The Contractor will not be required to maintain a field office at the construction site. In the event that the Contractor wishes to have a temporary project office, approval will be required by the Owner. The cost for the installation of all utilities will be paid by the Contractor.
11. DRAINAGE AND EROSION CONTROLS. The contractor will be responsible for designing, installing and maintaining interim drainage and erosion controls for the construction site. Surface drainage channels, culverts, or other features will be maintained by the contractor in such a way to minimize the impacts from storm water to offsite properties.
12. CONTRACT FORMS, BONDS AND CERTIFICATES. The Standard Form of Agreement bond forms listed below will be made a part of the executed contract documents and are made a part of these specifications:
 - a. PERFORMANCE BOND
 - b. PAYMENT BOND

These forms are not to be filled in by the bidder at the time of submitting his proposal.

**EXHIBIT A
STANDARD FORM OF AGREEMENT
CONSTRUCTION SERVICES**

**STANDARD FORM OF AGREEMENT
CONSTRUCTION SERVICES OVER \$50,000
(with bond forms)**

This Agreement is entered into by and between the **City of South Padre Island**, a Texas home-rule municipal corporation (the "City") and _____, a corporation (the "Contractor"), for the construction and/or installation of Laguna Boulevard Street and Drainage Improvements.

1. DEFINITIONS

1.01. Calendar Day. A "calendar day" is any day of the week or month, no days being excepted.

1.02. City. Whenever the word "City" is used, it shall mean and be understood as referring to the City of South Padre Island, Texas.

1.03. City's Representative. Whenever the words "City's Representative" or "Representative" are used, it shall mean and be understood as referring to the City Manager or his delegate, who shall act as City's agent. The City's Representative may inspect and issue instructions but shall not directly supervise the Contractor.

1.04. Contract Amount. The term "Contract Amount" shall mean the amount of Contractor's lump sum base bid proposal, together with all alternates, as accepted by the City in accordance with the Contractor's Proposal. In the case of a unit price contract, Contract Amount shall mean the sum of the product of all unit prices times the respective estimated final quantities of work, for all base bid and alternates, as accepted by the City.

1.05. Contract Documents. The term "Contract Documents" shall mean those documents listed in Paragraph 2.01.

1.06. Contractor. Whenever the word "Contractor" is used, it shall mean the person(s), partnership, or corporation who has agreed to perform the work embraced in this Agreement and the other Contract Documents.

1.07. Extra Work. The term "Extra Work" shall mean and include work that is **not** covered or contemplated by the Contract Documents but that may be required by City's Representative and approved by the City in writing **prior** to the work being done by the Contractor.

1.08. Final Completion. The term "Final Completion" shall mean that all the work has been completed, all final punch list items have been inspected and satisfactorily completed, all payments to materialmen and subcontractors have been made, all documentation and warranties have been submitted, and all closeout documents have been executed and approved by the City.

1.09. Interpretation of Phrases. Whenever the words "directed", "permitted", "designated", "required", "considered necessary", "prescribed", or words of like import are used, it is understood that the direction, requirement, permission, order, designation, or prescription of City's Representative is intended. Similarly, the words "approved", "acceptable", "satisfactory", or words of like import shall mean approved by, accepted by, or satisfactory to City's Representative.

1.10. Nonconforming work. The term "nonconforming work" shall mean work or any part thereof that is rejected by City 's Representative as not conforming with the Contract Documents.

1.11. Parties. The "parties" are the City and the Contractor.

1.12. Project. The term "Project" shall mean and include all that is required to obtain a final product that is acceptable to the City. The term "work" shall have like meaning.

1.13. Subcontractor. The term "subcontractor" shall mean and include only those hired by and having a direct contact with Contractor for performance of work on the Project. The City shall have no responsibility to any subcontractor employed by a Contractor for performance of work on the Project, and all subcontractors shall look exclusively to the Contractor for any payments due.

1.14. Substantially Completed. The term "Substantially Completed" means that in the opinion of the City's Representative the Project, including all systems and improvements, is in a condition to serve its intended purpose but still may require minor miscellaneous work and adjustment. Final payment of the Agreement Price, including retainage, however, shall be withheld until Final Completion and acceptance of the work by the City. Acceptance by the City shall not impair or waive any warranty obligation of Contractor.

1.15. Work. The term "work" as used in this Agreement shall mean and include all that is required herein to obtain a final product that is acceptable to the City. The term "Project" shall have like meaning. This Project includes the following:

1.16. Working Day. A "working day" means any day not including Saturdays, Sundays, or legal holidays.

2. CONTRACT DOCUMENTS

2.01. The Contract Documents and their priority shall be as follows:

- 2.01.01. This signed Agreement
- 2.01.02. Addendum to this Agreement
- 2.01.03. General Conditions
- 2.01.04. Special Conditions
- 2.01.05. Technical specifications
- 2.01.06. Drawings
- 2.01.07. Instructions to Bidders and any other notices to Bidders or Contractor
- 2.01.08. Performance bond, Payment bonds, Bid bonds and Special bonds
- 2.01.09. Contractor's Proposal

2.02. Where applicable, the Contractor will be furnished three (3) sets of plans, drawings, specifications, and related Contract Documents for its use during construction. Plans and specifications provided for use during construction shall be furnished directly to the Contractor only.

2.03. The Contractor shall distribute copies of the plans and specifications to suppliers and subcontractors as necessary. The Contractor shall keep one (1) copy of the plans and specifications accessible at the work site with the latest revisions noted thereon. For proper execution of the work contemplated by this Agreement, additional sets of drawings, plans and specifications may be purchased by the Contractor.

2.04. All drawings, specifications, and copies thereof furnished by the City shall not be re-used on other work, and with the exception of one (1) copy of the signed Contract Documents, all documents, including sets of the plans and specifications and "as built" drawings, are to be returned to the City on request at the completion of the work. All Contract Documents, models, mockups, or other representations are the property of the City. In the event of inconsistencies within or between parts of the Contract Documents, the Contractor shall (1) provide the better quality or greater quantity of Work, or (2) comply with the more stringent requirement, either or both in accordance with the City's interpretation. The terms and conditions of this Clause 2.04, however, shall not relieve the Contractor of any of the obligations set forth in Paragraphs 8.01. and 8.02.

3. AWARD OF CONTRACT

3.01. Upon the award of the contract by the City Council, the parties shall execute this Agreement, and the Contractor shall deliver to City's Representative all documents, bonds, and certificates of insurance required herein.

3.02. **Time is of the essence of this Agreement.** Accordingly, the Contractor shall be prepared to perform the work in the most expedient and efficient possible manner in order to complete the work by the times specified in this Agreement for Substantial Completion and Final Completion. In addition, the Contractor's work on the Project shall be commenced on the date to be specified in the notice to proceed. The notice to proceed may be given by oral notification or set by City's Representative at the post-contract award conference. **The notice to proceed may not be given, nor may any work be commenced, until this Agreement is fully executed and complete, including all required exhibits and other attachments, particularly those required under Paragraphs 27 and 28 (Insurance & Bonds).**

3.03. **Contract Amount.** Except in the event of a duly authorized change order approved by the City as provided in this Contract, and in consideration of the Contractor's final completion of all work in conformity with this Contract, the City shall pay the Contractor an amount not to exceed _____/100 Dollars (\$_____).

4. CITY'S REPRESENTATIVE

4.01. The Contractor shall forward all communications, written or oral, to the City through the City's Representative.

4.02. The City's Representative may periodically review and inspect the work of the Contractor.

4.03. The City's Representative shall appoint, from time to time, such subordinate supervisors or inspectors as City's Representative may deem proper to inspect the work performed under this Agreement and ensure that said work is performed in accordance with the plans and specifications.

4.04. The Contractor shall regard and obey the directions and instructions of City's Representative, any subordinate supervisors or inspectors appointed by the City provided such directions and instructions are consistent with the obligations of this Agreement.

4.05. Should the Contractor object to any orders by any subordinate supervisor or inspector, the Contractor may, within two (2) days from receipt of such order, make written appeal to City's Representative for his decision.

5. INDEPENDENT CONTRACTOR

5.01. In all activities or services performed hereunder, the Contractor is an independent contractor and not an agent or employee of the City. The Contractor, as an independent contractor, shall be responsible for the final product contemplated under this Agreement. Except for materials furnished by the City, the Contractor shall supply all materials, equipment and labor required for the execution of the work on the Project. The Contractor shall have ultimate control over the execution of the work under this Agreement. The Contractor shall have the sole obligation to employ, direct, control, supervise, manage, discharge, and compensate all of its employees and subcontractors, and the City shall have no control of or supervision over the employees of the Contractor or any of the Contractor's subcontractors except to the limited extent provided for in this Agreement.

5.02. The Contractor shall retain personal control and shall give its personal attention to the faithful prosecution and completion of the work and fulfillment of this Agreement. The subletting of any portion or feature of the work or materials required in the performance of this Agreement shall not relieve the Contractor from its obligations to the City under this Agreement. The Contractor shall appoint and keep on the Project during the progress of the work a competent Project Manager and any necessary assistants, all satisfactory to City's Representative, to act as the Contractor's representative and to supervise its employees and subcontractors. All directions given to the Project Manager shall be binding as if given to the Contractor. Adequate supervision by competent and reasonable representatives of the Contractor is essential to the proper performance of the work, and lack of such supervision shall be grounds for suspending the operations of the Contractor and is a breach of this Agreement.

5.03. Unless otherwise stipulated, the Contractor shall provide and pay for all labor, materials, tools, equipment, transportation, facilities, and drawings, including engineering, and any other services necessary or reasonably incidental to the performance of the work by the Contractor. It shall be the responsibility of the Contractor to furnish a completed work product that meets the requirements of the City. Any additional work, material, or equipment needed to meet the intent of this specification shall be supplied by the Contractor **without** claim for additional payment, even though not specifically mentioned herein.

5.04. Any injury or damage to the Contractor or the Project caused by an act of God, natural cause, a party or entity not privy to this Agreement, or other force majeure shall be assumed and borne by the Contractor.

6. DISORDERLY EMPLOYEES

The Contractor agrees to employ only orderly and competent employees skillful in the performance of the type of work required, and agrees that whenever City's Representative shall inform the Contractor in writing that any person or persons on the work are, in his opinion, incompetent, unfaithful, or disorderly, such person or person

shall be discharged from the work and shall not again be re-employed on the site or the Project without City's Representative's written permission.

7. HOURS OF WORK

The Contractor may work Monday through Friday from 7 a.m. to 6 p.m., exclusive of Saturdays, Sundays, or legal holidays. The Contractor may work overtime, weekends, and holidays only when approved in advance by the City's Representative. The time for Substantial Completion shall not be affected in any way by inclusion of this section or by the City's consent or lack of consent to work outside of the times specified in this Agreement.

8. NATURE OF THE WORK

8.01. It is understood and agreed that the Contractor has, by careful examination, studied and compared the various Drawings and other Contract Documents, satisfied itself as to the nature and location of the work, the conditions of the ground and soil, the nature of any structures, the character, quality, and quantity of the material to be utilized, the character of equipment and facilities needed for and during the prosecution of the work, the time needed to complete the work, Contractor's ability to meet all deadlines and schedules required by this Agreement, the general and local conditions, including but not limited to weather, and all other matters that in any way affect the work under this Agreement. These obligations are for the purpose of facilitating construction by the Contractor and are not for the purpose of discovering errors, omissions, or inconsistencies in the Contract Documents; however, any errors, inconsistencies or omissions discovered, or which reasonably should have been discovered by the Contractor shall be reported promptly to the City as a request for information in such form as the City may require. However, the Contractor shall not perform any act or do any work on the Project that places the safety of persons at risk or potentially damages materials or equipment used in the Project, and the Contractor shall do nothing that would render any test or tests erroneous.

8.02. Any design errors or omissions noted by the Contractor during this review shall be reported promptly to the City, but it is recognized that the Contractor's review is made in the Contractor's capacity as a contractor and not as a licensed design professional unless otherwise specifically provided in the Contract Documents. The Contractor is not required to ascertain that the Contract Documents are in accordance with applicable laws, statutes, ordinances, building codes, and rules and regulations, but any nonconformity discovered by or which reasonably should have been discovered or made known to the Contractor shall be reported promptly to the City.

8.03. If the Contractor fails to perform the obligations of Paragraphs 8.01. and 8.02., the Contractor shall pay such costs and damages to the City as would have been avoided if the Contractor had performed such obligations. The Contractor shall not be liable to the City for damages resulting from errors, inconsistencies or omissions in the Contract Documents or for differences between field measurements or conditions and the Contract Documents unless the Contractor recognized or reasonably should have recognized such error, inconsistency, omission or difference and knowingly failed to report it to the City.

9. POST-AGREEMENT AWARD MEETINGS

9.01. Prior to the commencement of the work, the parties shall meet and attend a post-agreement award meeting at the time and place determined by City's Representative. At the post-agreement award meeting, the parties shall meet, discuss, and finalize all schedules, including commencement date, and/or specifications submitted for review. No later than ten (10) days prior to the post-agreement award meeting, the Contractor shall submit to City's Representative the following documents:

- (a) Schedules of work contemplated, including the starting and ending date, as well as an indication of the completion of stages of work hereunder.
- (b) The names and addresses of all proposed subcontractors in writing.
- (c) Schedules of the starting and ending dates of subcontractors and the scope of work contemplated for subcontractors.
- (d) Name, local office, phone number and addresses and, home phone numbers for the Contractor and its Project Superintendent/Manager.
- (e) For construction projects, four (4) copies of all shop and/or setting drawings or schedules for the submission thereof.
- (f) Where applicable, materials procurement schedules and material supplier names, addresses and phone numbers.

9.02. The City's Representative, within five (5) working days after the initial post-agreement award conference or any other meetings, may submit minutes of the meeting to the Contractor. The Contractor shall thereafter have five (5) working days to review the minutes and make its objections, changes, or reductions thereto in writing. The Contractor shall thereafter sign the minutes and promptly return them to City's Representative. Where there is disagreement, City's Representative will make the final determination.

10. PROGRESS OF WORK

10.01. Unless otherwise specifically provided, the Contractor shall prosecute its work at such time and sessions, in such order of precedence, and in such manner as shall be most conducive to the economy of the Project; provided, however, that the order and time of prosecution shall be such that the Project shall be Substantially Completed in accordance with this Agreement, the plans and specifications, and within the time of completion designated in the schedules agreed upon by the parties.

10.02. Further, the parties shall be subject to the following:

- (a) The Contractor shall submit a progress schedule and payment schedule of the work contemplated by this Agreement at the initial post-agreement award meeting and subsequent meetings.
- (b) City's Representative shall be entitled to make objections to the Contractor's schedule submitted herein. The Contractor shall promptly resubmit a revised schedule to City's Representative.

(c) The Project Superintendent/Manager shall coordinate its activities with City's Representative. If required by the City, the Contractor shall provide a weekly schedule of planned activities, which may be reviewed on a daily basis.

(d) The Contractor shall submit, at such time as may reasonably be requested by City's Representative, additional schedules that shall list the order in which the Contractor proposes to carry on the work with dates at which the Contractor will start the several parts of the work and the estimated dates of completion of the several parts.

(e) The Contractor shall attend additional meetings called by City's Representative upon twenty-four (24) hours written notice unless otherwise agreed in writing by the parties.

(f) When the City is having other work done, either by agreement or by its own force, City's Representative may direct the time and manner of work done under this Agreement so that conflicts will be avoided and the various work being done by and for the City shall be coordinated.

(g) In the event that it is determined by the City that the progress of the work is not in accordance with the approved progress and payment schedule, the City may so inform the Contractor and require the Contractor to take such action as is necessary to insure completion of the Project within the time specified.

10.03. The process of approving Contractor's schedules and updates to Contractor's schedules shall not constitute a warranty by the City that any non-Contractor milestones or activities will occur as set out in the Contractor's schedules. Approval of a contractor's schedules does not constitute a commitment by the City to furnish any City-furnished information or material any earlier than the City would otherwise be obligated to furnish that information or material under the Contract Documents. Failure of the Work to proceed in the sequence scheduled by Contractor shall not alone serve as the basis for a Claim for additional compensation or time. In the event there is interference with the Work which is beyond its control, Contractor shall attempt to reschedule the Work in a manner that will hold the additional time and costs beyond its control to a minimum. The Contractor shall monitor the progress of the Work for conformance with the requirements of the construction schedules and shall promptly advise the City of any delays or potential delays. In the event any schedule indicates any delays, the Contractor shall propose an affirmative plan to correct the delay. In no event shall any schedule constitute an adjustment in the Contract Time, any Milestone Date or the Contract Sum unless any such adjustment is agreed to by the City and authorized pursuant to Change Order.

10.04. **Work Stoppage.** If in the judgment of either the City or City's Representative any of the work or materials furnished is not in strict accordance with this Agreement or any portion of the work is being performed so as to create a hazardous condition, they may, in their sole discretion, order the work of the Contractor or any sub contractor wholly or partially stopped until any objectionable person, work, or material is removed from the premises. Such stoppage or suspension shall neither invalidate any of the Contractor's performance obligations under this Agreement, including the time of performance and deadlines therefore, nor will any extra charge be allowed the Contractor by reason of such stoppage or suspension.

11. SITE CONDITIONS AND MANAGEMENT

11.01. Where the Contractor is working around or in existing structures, it shall verify conditions at the site, including but not limited to, door openings and passages. Any items constructed or manufactured off-site or outside of buildings shall be done so that they are not too bulky for existing facilities. The Contractor shall provide special apparatus as required to handle any such items. All special handling equipment charges shall be at the Contractor's expense. Further, Contractor shall include in its price for the Work, all labor, materials, equipment and/or engineering services required to protect the adjacent properties and/or structures from damage due to performance of the Work.

11.02. The Contractor shall be responsible for all power, light, and water required to perform the work.

11.03. Throughout the progress of the work, the Contractor shall keep the working area free from debris of all types, and remove from premises all rubbish, resulting from any work being done by him. At the completion of the work, the Contractor shall leave the premises in a clean and finished condition. Any failure to do so may be remedied and charged back to the Contractor.

11.04. **Layout of Work.** Except as specifically provided herein, the Contractor shall lay out all work in a manner acceptable to City's Representative in accordance with applicable City of South Padre Island codes and ordinances. City's Representative will review the Contractor's layout of all structures and any other layout work done by the Contractor at the construction meeting, or at the Contractor's request, but this review does not relieve the Contractor of the responsibility of accurately locating all work in accordance with the plans and specifications.

11.05. **Lines and Grades.** All lines and grades shall be furnished by the Contractor. Benchmarks and control stakes have been provided by the City's Representative. All benchmarks and control stakes shall be carefully preserved by the Contractor. In case of destruction or removal of the same by the Contractor, its subcontractors, or employees, such stakes, marks, etc. shall be replaced by the Contractor at the Contractor's expense. If the Contractor fails to do so, the City may do so and charge back the Contractor. Additional construction staking as needed for the work, including lines and grades, shall be the sole responsibility of the Contractor, and the Contractor shall receive no extra time or compensation therefor.

11.06. **Contractor's Structures.** The building or locating of structures for housing men or the erection of tents or other forms of protection will be permitted only at such places as City's Representative shall permit. The Contractor shall not damage the property where such structures are allowed and shall at all times maintain sanitary conditions in and about such structures in a manner satisfactory to the City. The City may charge the Contractor for any damage or injury to the City, its property, or third persons as a result of the location or use of such structures.

11.07. The Contractor and any entity over whom the Contractor has control shall not erect any sign on the Project site without the prior written consent of the City.

11.08. City may have other work related to the Project performed at the Project site during the time the Work is performed. Contractor should schedule its Work to coordinate with the work of other contractors and utilities with the understanding that some of that work may be performed at times other than as set out in the Contract Documents or as otherwise anticipated. City will endeavor to have such other work performed so as not to unduly interfere with Contractor's performance when Contractor notifies City of specific reasonable needs well in advance of those needs and where it is possible to do so. Although Contractor should anticipate some delays and interference to its sequence of Work because of work by other contractors and utilities, and will not be entitled to either an extension of time or additional compensation because of them, in the event of substantial delay caused by another contractor or a utility, after advance notice of its needs by Contractor, Contractor will be entitled to make a claim for an extension of time as provided herein.

11.09. When two or more contractors, including Contractor, are employed on related or adjacent work or obtain materials from the same material source, or when work must be completed by one contractor before another can begin, each shall conduct his operations in such a manner as not to cause any unnecessary delay or hindrance to the other. Each contractor, including Contractor if applicable, shall be responsible to the other for all damage to work, to persons, or to property caused to the other by his operations, and for loss caused the other due to unreasonable or unjustified delays or failure to finish the work or portions thereof, or furnish materials within the time requested. Should Contractor cause damage to the work or property of any separate contractor at the Project site, or should any claim arising out of Contractor's separate contractor at the Project site, or should any claim arising out of Contractor's performance of the Work at the Project site be made by any separate contractor against Contractor, City or other consultants, or any other person, Contractor shall promptly attempt to settle with such other contractor by agreement, or to otherwise resolve the dispute. **Contractor shall, to the fullest extent permitted by applicable laws, indemnify and hold City harmless from and against all claims, damages, losses and expenses (including, but not limited to, fees of architects, attorneys and other professionals and court costs) arising directly, indirectly or consequentially out of any action, legal or equitable, brought by any separate contractor against City to the extent based on a claim arising out of Contractor's negligence.**

12. MATERIALS

12.01. Materials or work described in words that when so applied have well-known technical or trade meaning shall be held to refer to such recognized standards. All work shall be done and all materials furnished in strict conformity with this Agreement, the other Contract Documents, and recognized industry standards. When specific products, systems or items of equipment are referred to in the Contract Documents, any ancillary devices necessary for connecting the products, systems or items of equipment shall also be provided. When standards, codes, manufacturer's instructions and guarantees are required by the Contract Documents, the current edition at the time of Contract execution shall apply, unless another edition is specified in the Contract Documents.

References to standards, codes, manufacturer's instructions and guarantees shall apply in full, except (1) they do not supersede more stringent standards set out in the Contract Documents, and (2) any exclusions or waivers that are inconsistent with the Contract Documents do not apply.

12.02. All materials shall be approved by the City prior to purchase by the Contractor. Unless otherwise specified herein, the Contractor shall purchase all materials and equipment outright and shall not subject the materials and equipment utilized in the Project to any conditional sales agreement, bailment, lease, or other agreement reserving unto seller any right, title, or interest therein. Title to all materials, but not risk of loss, shall pass to the City upon delivery to the Project.

12.03. Where the City deems it necessary to supply materials, it may furnish to the Contractor the list of materials set forth in the attached "List of City Furnished Materials". Upon receipt of said materials, the Contractor shall immediately furnish to the City a written receipt. Moreover, the Contractor shall, on behalf of the City, accept delivery of the materials set forth in the attached "List of Materials Ordered by the City". Under such circumstances, the Contractor shall promptly forward to the City for payment the supplier's invoice together with the Contractor's receipt in writing for such materials.

(a) Upon acceptance of the materials furnished or ordered by the City, the Contractor warrants that it shall properly handle, transport, store and safeguard the materials.

(b) Further, the Contractor shall repair, repaint or replace any and all materials or any part thereof damaged or stolen while in its possession. Such materials are considered to be in the Contractor's possession from the moment the Contractor either accepts delivery of the materials or signs a receipt accepting delivery of said materials until the Project is accepted by the City's Representative.

(c) Before transporting any of the materials furnished or ordered by the City, the Contractor shall establish to the City's satisfaction that it has obtained insurance against losses, theft, damage, equal to or greater than the amounts spent by the City in securing said materials. It shall be incumbent upon the Contractor to verify the cost of materials.

(d) The City shall not be obligated to furnish materials in excess of the quantities, size, kind, and type set forth in the attached List of City Furnished Materials and List of Materials Ordered by the City. If the City furnishes, and the Contractor accepts, materials in excess thereof, the values of such excess materials shall be their actual cost as stated by the City.

(e) Upon delivery, the Contractor shall promptly receive, unload, transport, and handle all materials and equipment on the List of Materials Ordered by the City at its expense and shall be responsible for all shipping costs.

12.04. **Materials and supplies shall be new and of good quality.** Upon request, the Contractor shall supply proof of quality and manufacturer. No refurbished, reconditioned, or other previously utilized materials or supplies will be used without the prior signed authorization of City's Representative. The Contractor may utilize substitutes of equal quality and function only upon the prior written authorization of the City's Representative. The City's Representative may require documentation as to quality and function, including manufacturer's specifications, to insure that the proposed substitute is equal to the required material or supply. The City's Representative shall have sole

discretion over the use of substitute materials and supplies. Contractor shall bear the risk of any delay in performance caused by submitting substitutions.

12.05. Only materials and equipment which are to be used directly in the Work shall be brought to and stored on the Project site by the Contractor. After equipment is no longer required for the Work, it shall be promptly removed from the Project site. Protection of construction material and equipment stored at the Project site from weather, theft, damage and all other perils is solely the responsibility of the Contractor.

13. ENTRY, OBSERVATION, TESTING & POSSESSION

13.01. The City reserves the right to enter the Project site or sites by such employee(s) or agent(s) as it may elect for the purpose of inspecting the work. The City further reserves the right to enter the Project site or sites for the purpose of performing such collateral work as the City may desire.

13.02. The City's Representative shall have the right, at all reasonable times, to observe and test the work. The Contractor shall make necessary arrangements and provide proper facilities and access for such observation and testing at any location where the work or any part thereof is in preparation or progress. The Contractor shall ascertain the scope of any observation that may be contemplated by City's Representative and shall give ample notice as to the time each part of the work will be ready for observation.

13.03. The City's Representative may require Contractor to remove, dismantle, or uncover completed work. If the work is not in accordance with the plans, specifications, or other Contract Documents, the Contractor shall pay the costs of repair and restoration of the work required to be removed, dismantled, or uncovered. Unless Contractor is obligated to provide advance notice of inspection, prior to covering up the work, and fails to do so, if the work is in accordance with the plans, specifications, and other Contract Documents, the City shall pay the costs of repair and restoration of the work.

13.04. City shall have the right to take possession of and use any completed or partially completed portions of the Project prior to the time for completing the entire Project or such portions which may not have expired. The parties agree and understand that possession and use shall not constitute an acceptance of any work not completed in accordance with this Agreement. Further, insurance changes required to keep Contractor's insurance in effect shall be the responsibility of Contractor.

14. REJECTED WORK

14.01. All work deemed not in conformity with this Agreement as determined by the City in its sole discretion, may be rejected by the City. City's Representative may reject any work found to be defective or not in accordance with the Contract Documents, regardless of the stage of the work's completion or the time or place of discovery of such defects or inconsistencies and regardless of whether City's Representative has previously accepted the work through oversight or otherwise. Neither observations nor inspections, tests, or approvals made by City's Representative, or other persons authorized under this Agreement to make such observations, inspections, tests, or approvals, shall relieve the Contractor from the obligation to perform the work in accordance with the requirements of this Agreement and the other Contract Documents.

14.02. If the work or any part thereof is rejected by the City, it shall be deemed by City's Representative as not in conformity with this Agreement. Any remedial action required, as set forth herein, shall be at the Contractor's expense, as follows:

(a) The Contractor may be required, at the City's option, after notice from City's Representative, to remedy such work so that it shall be in full compliance with this Agreement. All rejected work or materials shall be immediately replaced in order to conform with this Agreement.

(b) If the City deems it inexpedient to correct work damaged or not done in accordance with this Agreement, an equitable deduction from the agreed sum may be made by the City at the City's sole discretion.

15. SUBCONTRACTING & SUBCONTRACTORS

15.01. The Contractor agrees that it will retain personal control and will give its personal attention to the fulfillment of this Agreement. The Contractor further agrees that subletting of any portion or feature of the work or materials required in the performance of this Agreement shall not relieve the Contractor from its full obligation to the City as provided by this Agreement.

15.02. Subcontractors must be approved by City's Representative prior to hiring or beginning any work on the Project. If City's Representative judges any subcontractor to be failing to perform the work in strict accordance with the drawings and specifications, the Contractor, after due notice, shall discharge the same, but this shall in no way release the Contractor from its obligations and responsibility under this Agreement. Every subcontractor shall be bound by the terms and provisions of this Agreement and the Contract Documents as far as applicable to their work. The Contractor shall be fully responsible to the City for the acts and omissions of its subcontractors. Nothing contained herein shall create any contractual or employment relations between any subcontractor and the City.

16. PAYMENT

16.01. The City stipulates that it is an exempt organization as defined by the Limited Sales, Excise and Use Tax Act and, as such, is exempt from the payment of the sales tax on materials and supplies used in the performance of this Contract. The Contractor shall issue exemption certificates to its suppliers and Subcontractors in lieu of said sales tax for all such materials and supplies, and said exemption certificates must comply with the State Comptroller's Ruling No. 95-0.07 and shall be subject to the provision of the State Comptroller's Ruling No. 95-0.09, effective October 1, 1969.

16.02. **Progress Payment Applications.** The Contractor shall submit applications for payment as provided for herein. Applications for payment will be processed by City's Representative. Before the first Application for Payment, the Contractor shall submit to the City a schedule of values allocated to various portions of the Work, prepared in such form and supported by such data to substantiate its accuracy as the City may require. This schedule, unless objected to by the City, shall be used as a basis for reviewing the Contractor's Applications for Payment. On or before the ____ day of each month, the Contractor shall submit to City's Representative, for approval or modification, a statement showing as completely as practicable the total value of the actual work performed by the Contractor and accepted by the City up to and including the last day of the *preceding* month. The statement shall also include the value of all materials not previously submitted for payment which have been delivered to the site but have not yet been incorporated into the work.

16.03. Progress Payments. On or before the **30th** calendar day following the City's receipt of a progress payment application made in conformity with Paragraph 16.02, the City shall pay to the Contractor the approved amount of the progress payment based on the Contractor's applications for payment, and the recommendation and approval of City's Representative. Prior to Substantial Completion, progress payments will be made in an amount equal to the percentage of work completed by the Contractor and approved by the City, but in each case less the aggregate of payments previously made, less retainage, and less amounts as City's Representative shall determine and the City may withhold in accordance with this Agreement. Upon Final Completion, including the delivery of all close out documents, such as "as built" drawings, warranties, guarantees, required additional materials, releases, operation and maintenance manuals, and acceptance of the work in accordance with this Agreement, the City shall pay the remainder of the balance due under this Agreement, less any sums withheld under other terms of this Agreement and less the retainage, which shall be retained for a period of thirty (30) calendar days from the date of Final Completion. Acceptance of retainage by Contractor shall constitute a Waiver and Release of all claims by Contractor.

16.04. Retainage. From each approved statement, the City shall retain until final payment, ten percent (10%), where the full contract amount is less than \$400,000.00, and five percent (5%), where the full contract amount is \$400,000.00 or more. The City may also retain from each approved statement any other sums authorized under the terms of this Agreement.

16.05. If the actual amount of work to be done and the materials to be furnished differ from estimates and where the basis for payment is the unit price method, then payment shall be for the actual amount of accepted work done and materials furnished on the Project.

16.06. Reduction in the scope or quantity of work on unit price items shall merely reduce the number of units. In the event that materials have been delivered prior to notice of such reduction, the City will have the option either to pay freight & transportation costs and any re-stocking charges actually incurred by the Contractor or to purchase the materials. The Contractor shall never be entitled to anticipated or lost profits on the deleted or reduced portion of a job, whether bid on a unit price or lump sum basis.

16.07. The Contractor shall have the sole obligation to pay any and all charges or fees and give all notices necessary to and incidental to the lawful prosecution of the work hereunder. The Contractor shall not and shall have no authority whatsoever to obligate the City to make any payments to another party nor make any promises or representation of any nature on behalf of the City, without the specific written approval of the City.

16.08. The Contractor shall include in the Contract Sum all allowances stated in the Contract Documents. Items covered by allowances shall be supplied for such amounts and by such persons or entities as the City may direct, but the Contractor shall not be required to employ persons or entities to whom the Contractor has reasonable objection.

16.09. Unless otherwise provided in the Contract Documents:

- (a) allowances shall cover the cost to the Contractor of materials and equipment delivered at the site and all required taxes, less applicable trade discounts;
- (b) Contractor's costs for unloading and handling at the site, labor, installation costs, overhead, profit and other expenses contemplated for stated allowance amounts shall be included in the Contract Amount but not in the allowances;

- (c) whenever costs are more than or less than allowances, the Contract Amount shall be adjusted accordingly by Change Order. The amount of the Change Order shall reflect (1) the difference between actual costs and the allowances under Paragraph 16.9(a) and (2) changes in the Contractor's costs under Paragraph 16.9(b).

16.10. Suspension of Payments. The City, at any time, may suspend monthly progress payments on the work if it determines that the projected liquidated damages may exceed retainage. The City, at any time, may suspend monthly progress payments if it believes that the Contractor will not complete the work due to actual default or that the Contractor has represented or done some act that indicates that it will not complete the work in accordance with this Agreement or within the time period submitted in its bid. Provided, however, City is in no way obligated to Contractor's surety to withhold payment pursuant to the provisions of this Paragraph.

16.11. Withhold Funds. Regardless of any bond, the City may, on account of subsequently discovered evidence and in addition to the retainage withheld under Paragraph 16.04, withhold funds or nullify all or part of any acceptance or certificate to such extent as may be necessary to protect itself from loss on account of any of the following, or as otherwise provided in this Agreement:

- (a) Defective work.
- (b) Claims made or reasonable evidence indicating probable filing of claims by unpaid vendors or other third parties.
- (c) Failure of the Contractor to make prompt payments to subcontractors for labor or material or materialmen.
- (d) Claims made or reasonable evidence indicating claims will be made for damage to another by the Contractor.
- (e) Claims made or reasonable evidence indicating claims will be made for damage to third parties, including adjacent property owners.
- (f) Claims made or reasonable evidence indicating claims will be made for unremedied damage to property owned by the City.
- (g) City's determination of an amount of liquidated damages.
- (h) Charges made for repairs to the Contractor's defective work or repairs made by the City to correct damage to other property.
- (i) Other amounts authorized under this Agreement or under any other agreement made between City and Contractor.

Provided, however, City is in no way obligated to Contractor's surety to withhold payment pursuant to the provisions of this Paragraph.

17. EXTRA WORK CHARGES

17.01. No changes shall be made, nor will bills for changes, alterations, modifications, deviations, and extra orders be recognized or paid for except upon the written order from authorized personnel of the City.

17.02. For "Extra Work", as defined in Paragraph 1.07 and authorized through written change orders, and pursuant to Section 252.048(d) of the Texas Local Government Code, the original contract price may not be increased by more than **twenty-five percent (25%)**. Written change orders that do not exceed **twenty-five percent (25%)** of the original contract amount may be made or approved by the City Manager or his delegate if the change order is less than **Fifty Thousand Dollars (\$50,000.00)**. Changes in excess of **Fifty Thousand Dollars (\$50,000.00)** must be approved by the City Council prior to commencement of the services or work. **Any requests by the Contractor for a change to the Contract Amount shall be made prior to the beginning of the work covered by the proposed change or the right to payment for Extra Work shall be waived.** No course of conduct or dealings between the parties, nor implied acceptance of alterations or additions to the Work or changes to the Contract schedule shall be the basis for any claim for an increase in compensation or change in time. Any cost incurred by Contractor in connection with any Extra Work shall be included in Contractor's requested change order and Contractor's failure to include any such cost shall act to Waive and Release any claim for such non included cost.

17.03. The Contractor shall complete all work as specified or indicated in the Contract Documents. The Contractor shall complete all Extra Work in connection therewith. All work and materials shall be in strict conformity with the specifications. The Substantial Completion of the work shall not excuse the Contractor from performing all the work undertaken, whether of a minor or major nature, and thereby completing the Project in accordance with the Contract Documents. In the event that the Contractor fails to perform the work as required for Substantial Completion or Final Completion, the City may contract with a third party to complete the work and the Contractor shall assume and pay the costs of the performance of the work as contracted.

(a) It is agreed that the Contractor shall perform all Extra Work under the direction of City's Representative when presented with a written work order signed by City.

(b) **No claim for Extra Work of any kind will be allowed unless ordered in writing by the City.** In case any orders or instructions appear to the Contractor to involve Extra Work for which it should receive compensation or an adjustment in the construction time, it shall make written request to City's Representative for a written order from City authorizing such Extra Work.

(c) Should a difference of opinion arise as to what does or does not constitute Extra Work, or as to the payment therefor, and the City insists upon its performance, then the Contractor shall proceed with the work after making written requests for written orders in a change order and shall keep adequate and accurate account of the actual field costs therefor, as provided under Method C.

(d) It is also agreed that the compensation to be paid to the Contractor for performing Extra Work shall be determined by one or more of the following methods:

Method A - By agreed unit prices, or

Method B - By agreed lump sum, or
Method C - If neither Method A nor Method B is agreed upon before the
Extra Work is commenced, then the Contractor shall be paid
the actual field cost of the work.

(e) **Method A - Unit Prices.** The Contractor agrees to perform Extra Work for the unit prices in the Contractor's Proposal. The Contractor also agrees and warrants that when it is necessary to construct units not shown in the Contract Documents, it shall construct such units for a price arrived at as follows:

(1) The cost of materials shall be determined by the invoices;

(2) The cost of labor shall be the reasonable cost thereof, as determined by the City, but in no event shall it exceed an amount determined by calculating the ratio of the total labor costs to the total costs to the total material costs in the section of the Proposal involved, and multiplying the cost of materials for the unit in question by this ratio. Provided, however, that the ratio shall be calculated for only those units that are similar to the new unit for which a price is to be determined.

(f) **Method B - Lump Sum.** The lump sum shall be reasonably close to the amount for similar work previously done or combinations of similar units. Invoices for materials used shall be provided in support of the agreed lump sum.

(g) **Method C - Actual Field Costs.** The actual field cost is hereby defined to include the cost of all applicable workmen and laborers, as well as materials, supplies, teams, trucks, rentals on machinery and equipment, for the time actually employed or used for such Extra Work, plus actual transportation charges necessarily incurred, together with other costs reasonably incurred directly on account of such Extra Work, including social security, old age benefits, maintenance bonds, public liability, property damage, worker's compensation, and all other insurance as may be required by law or ordinances or required and agreed to by the City or City's Representative. City's Representative may direct the form in which accounts of the actual field costs shall be kept and records of these accounts shall be made available to City's Representative. Unless otherwise agreed upon, the prices for the use of machinery and equipment shall be determined by using one hundred percent (100%), unless otherwise specified, of the latest schedule of equipment and ownership expenses adopted by the Associated General Contractors of America. Where practical, the terms and prices for the use of machinery and equipment shall be incorporated in the written Extra Work order. Actual field costs shall not exceed the prevailing market price therefor within reasonable tolerances as determined by City's Representative. The amount due to Contractor for costs other than actual field costs shall be calculated in accordance with the following standards:

(1) No indirect or consequential damages will be allowed.

(2) All damages must be directly and specifically shown to be caused by a proven wrong. No recovery shall be based on a comparison by planned expenditures to total actual expenditures or on estimated losses of labor efficiency, or on a comparison of planned manloading to actual manloading, or any other analysis that is used to show damages indirectly.

- (3) Damages are limited to extra costs specifically shown to have been directly caused by a proven wrong.
- (4) The maximum daily limit on any recovery for delay shall be the amount established by the Contractor for job overhead costs, defined in the pay applications, divided by the total number of days specified for completion called for in the original Contract. Absent an overhead amount in the Schedule of Values, the amount estimated by Contractor for job overhead cost shall be used.

18. TIME OF COMPLETION

18.01. The date of beginning, the time for Substantial Completion and Final Completion of work as specified in this Agreement are of the essence of this Agreement.

18.02. The work embraced by this Agreement shall be commenced on the date specified in the notice to proceed. Said notice to proceed may be given orally or set by the City's Representative at the post-award conference.

18.03. The work shall be Substantially Completed within the time bid, which shall run from the date when the notice to proceed is given by City's Representative. The Contractor bid 730 calendar days for the time within which it shall reach Substantial Completion of the Project.

18.04. The work shall reach Final Completion and be ready for final payment within **thirty (30) calendar days** from the date of Substantial Completion.

19. SUBSTANTIAL COMPLETION

19.01. The Contractor shall notify City's Representative when, in the Contractor's opinion, the contract is Substantially Completed. Within ten (10) calendar days after the Contractor has given City's Representative written notice that the work has been Substantially Completed, City's Representative shall inspect the work for the preparation of a final punch list.

(a) If City's Representative and the City find that the work is not Substantially Completed, then they shall so notify the Contractor who shall then complete the work. City's Representative shall not be required to provide a list of unfinished work.

(b) If the City Representative and City find that the work is Substantially Completed, the City shall issue to the Contractor its certificate of Substantial Completion.

19.02. The Substantial Completion of the work shall not excuse the Contractor from performing all of the work undertaken, whether of a minor or major nature, and thereby completing the Project in accordance with the Contract Documents.

20. FINAL COMPLETION

20.01. Contractor shall notify the City's Representative when it believes that the work has reached Final Completion as defined in Paragraph 1.08. If the City's Representative and the City accept and deems such work Finally Complete, then Contractor shall be so notified and certificates of completion and acceptance, as provided herein, shall be issued. A complete itemized statement of this Agreement account, certified by the City's Representative as correct, shall then be prepared and delivered to Contractor. Contractor or City, as the case may be, shall pay the balance due as reflected by said statement within thirty (30) calendar days.

20.02. The Contractor shall procure all required certificates of acceptance or completions issued by state, municipal, or other authorities and submit the same to the City. The City may withhold any payments due under this Agreement until the necessary certificates are procured and delivered.

20.03. Neither the final payment nor any acceptance nor certificate nor any provision of this Agreement shall relieve the Contractor of any responsibility for faulty workmanship or materials. At the option of the City, the Contractor shall remedy any defects and pay for any damage to other work which may appear after final acceptance of the work.

21. DELAYS

21.01. The Contractor, in undertaking to complete the work within the times herein fixed, has taken into consideration and made allowance for all hindrances and delays incident to such work, whether growing out of delays in securing material or workmen or delays arising from inclement weather or otherwise.

21.02. The City may, in its sole discretion, delay the work during inclement weather in order to preserve the Project, insure safety of work forces, and the preservation of materials and equipment. In such event and upon a written request from the Contractor, the City may grant an extension of time pursuant to Paragraph 22 to offset for such stoppage of the work.

21.03. In the event of delays resulting from changes ordered in the work by the City or other delays caused by the City or for the City's convenience, the Contractor may apply to the City for recovery of incidental damages resulting from increased storage costs or other costs necessary to protect the value of the work. In no event shall any consequential or other damages be allowed or any other charges or claims be made by the Contractor for hindrances or delays resulting from any other cause.

22. EXTENSIONS OF TIME

The Contractor has submitted its proposal in full recognition of the time required for the completion of this Project, taking into consideration all factors including, but not limited to the average climatic range and industrial conditions. The Contractor has considered the liquidated damage provision of this Agreement and understands and agrees that it shall not be entitled to, nor will it request, an extension of time for either Substantial Completion or Final Completion, except when the work has been delayed by one or more of the following:

- (1) an act or neglect of the City, the City's Representative, employees of the City, or other contractors employed by the City;
- (2) by changes ordered in the work, or reductions thereto approved in writing;
- (3) by "rain days" (days with rainfall in excess of one-tenth of an inch) during the term of this Agreement that exceed the average number of rain days for such term for this locality, both as determined by the Texas A&M University weather service; or
- (4) by other causes that the City and the Contractor agree may reasonably justify delay and that were beyond the Contractor's reasonable control and ability to estimate, predict, or avoid, such as delays caused by unforeseen labor disputes, fire, natural disasters, acts of war, and other rare and unpredictable events. This term does **not** include normal delays incident to the delivery of materials, tools, or labor that reasonably could have been predicted and/or accounted for in the Contractor's proposal or decision to bid.

If one or more of the foregoing conditions is present, the Contractor may apply in writing for an extension of time, within thirty (30) days of the occurrence of the event causing the delay, submitting therewith all written justification as may be required by the City's Representative. Within ten (10) calendar days after receipt of a written request for an extension of time, which is supported by all requested documentation, the City shall, in writing and in its sole discretion, grant or deny the request. Under no circumstances shall any extension of time by the City be valid and binding unless it is in writing and in conformity with the other terms of this Agreement.

23. LIQUIDATED DAMAGES

23.01. The time for the Substantial and Final Completion of the work described herein are reasonable times for the completion of each, taking into consideration all conditions, including but not limited to the average climatic conditions and usual industrial conditions prevailing in this locality. The amount of liquidated damages for the Contractor's failure to meet the deadlines for Substantial and/or Final Completion are fixed and agreed on by the Contractor because of the impracticability and extreme difficulty in fixing and ascertaining the actual damages that the City would in such an event sustain. The amounts to be charged are agreed to be damages the City would sustain and shall be retained by the City from current periodic estimates for payment or from final payment.

23.02. As a result of the difficulty in estimation, calculation and ascertainment of City's damages due to a failure of Contractor to achieve timely completion of the Work, if the Contractor should neglect, fail, or refuse to either Substantially Complete or Finally Complete the work within the time herein specified, or any proper extension thereof granted by the City's Representative pursuant to the terms of Paragraph 22 of this Agreement, then the Contractor does hereby agree as part of the consideration for the awarding of this Agreement that the City may permanently withhold from the Contractor's total compensation the sum of _____/100 DOLLARS (\$) for each and every calendar day that the Contractor shall be in default after the time stipulated for Substantial Completion and/or Final Completion, not as a penalty, but as liquidated damages for the breach of this Agreement. It being specifically understood that the assessment of liquidated damages may be made for any failure to meet either or both of the deadlines specified for Substantial Completion and/or Final Completion.

24. CHARGES FOR INJURY OR REPAIR

24.01. The Contractor shall be liable for any damages incurred or repairs made necessary by reason of its work and/or caused by it. Repairs of any kind required by the City will be made and charged to the Contractor by the City.

24.02. The Contractor shall take the necessary precautions to protect any areas adjacent to its work.

24.03. The work specified consists of all work, materials, and labor required by the City to repair any damage to the property of the City, including but not limited to structures, roadways, curbs, parking areas, and sidewalks.

25. WARRANTY

25.01. Upon issuance of a certificate of Final Completion, the Contractor warrants for a period of one (1) year as follows:

The Contractor warrants that all materials provided to the City under this Agreement shall be new unless otherwise approved in advance by City's Representative and that all work will be of good quality, free from faults and defects, and in conformance with this Agreement, the other Contract Documents, and recognized industry standards.

25.02. All work not conforming to these requirements, including but not limited to unapproved substitutions, may be considered defective.

25.03. This warranty is in addition to any rights or warranties expressed or implied by law and in addition to any consumer protection claims arising from misrepresentations by the Contractor.

25.04. Where more than a one (1) year warranty is specified for individual products, work, or materials, the longer warranty shall govern.

25.05. This warranty obligation shall be covered by any performance or payment bonds tendered in compliance with this Agreement.

25.06. **Defective Work Discovered During Warranty Period.** If any of the work is found or determined to be either defective, including obvious defects, or otherwise not in accordance with this Agreement within one (1) year after the date of the issuance of a certificate of Final Completion of the work or a designated portion thereof, whichever is longer, or within one (1) year after acceptance by the City of designated equipment, or within such longer period of time as may be prescribed by law or by the terms of any applicable special warranty required by this Agreement, the Contractor shall promptly correct the defective work at no cost to the City.

25.07. After receipt of written notice from the City to begin corrective work, the Contractor shall promptly begin the corrective work. The obligation to correct any defective work shall survive the termination of this Agreement. The guarantee to correct the defective work shall not constitute the exclusive remedy of City, nor shall other remedies be limited to the terms of either the warranty or the guarantee.

25.08. If within ten (10) calendar days after the City has notified the Contractor of a defect, failure, or abnormality in the work, the Contractor has not started to make the necessary corrections or adjustments, the City is hereby authorized to make the corrections or adjustments, or to order the work to be done by a third party. The cost of the work shall be paid by the Contractor or its surety.

25.09. The cost of all materials, parts, labor, transportation, supervision, special instruments, and supplies required for the replacement or repair of parts and for correction of defects shall be paid by the Contractor or by the surety.

25.10. The guarantee shall be extended to cover all repairs and replacements furnished, and the term of the guarantee for each repair or replacement shall be one (1) year after the installation or completion. The one (1) year warranty shall cover all work, equipment, and materials that are part of this Project, whether or not a warranty is specified in the individual section of the Contract Documents that prescribe that particular aspect of the work.

26. PAYMENT OF EMPLOYEES, SUBCONTRACTORS & SUPPLIERS

26.01. **Wage Rates.** Pursuant to Section 2258.023(a) of the Texas Government Code, wage rates paid by the Contractor and any subcontractor on this Project shall be not less than the general prevailing rate of per diem wages for work of a similar character in this locality as specified in the schedule of general prevailing rates of per diem wages attached hereto as Exhibit A.

26.02. **Statutory Penalty.** Pursuant to Section 2258.023(b) of the Texas Government Code, if the Contractor or any subcontractor violates the requirements of Paragraph 26.01, the Contractor or subcontractor as the case may be shall pay the City **Sixty Dollars (\$60.00)** for each worker employed for each calendar day or part of the day that the worker is paid less than the stipulated wage rates.

26.03. The Contractor and each subcontractors shall pay all of their employees engaged in work on the Project in full (less mandatory legal deductions) in cash or by check readily cashable, without discount, no less than once each week.

26.04. No later than the seventh (7th) calendar day following the payment of wages, the Contractor must file with City's Representative a certified, sworn, legible copy of such payroll. This shall contain the name of each employee, their classification, the number of hours worked on each day, rate of pay, and net pay. The affidavit shall state that the copy

is a true and correct copy of such payroll and that no rebates or deductions (except as shown) have been made or will be made in the future from the wages therein shown.

26.05. Payment of Subcontractors. The Contractor shall be solely and exclusively responsible for compensating any of the Contractor's employees, subcontractors, materialmen and/or suppliers of any type or nature whatsoever and for insuring that no claims or liens of any type arising out of or incidental to the performance of any services performed pursuant to this Agreement are filed against any property owned by the City. In the event a statutory lien notice is sent to the City, the Contractor shall, where no payment bond covers the work, upon written notice from the City, immediately obtain a bond at its expense and hold the City harmless from any losses that may result from the filing or enforcement of any said lien notice. In the event that the Contractor defaults in the provision of the bond, the City may withhold such funds as are necessary to assure the payment of such claim until litigation determines to whom payment shall be made.

26.06. Affidavit of Bills Paid. Prior to Final Acceptance of the Project, the Contractor shall provide a notarized affidavit stating that all bills for labor, materials, and incidentals incurred have been paid in full, that any claims from manufacturers, materialmen, and subcontractors have been released, and that there are no claims pending of which the Contractor has been notified.

27. INSURANCE

27.01. The Contractor shall procure and maintain at its sole cost and expense for the duration of this Agreement insurance against claims for injuries to persons or damages to property that may arise from or in connection with the performance of the work hereunder by the Contractor, its agents, representatives, volunteers, employees or subcontractors. The policies, coverages, limits and endorsements required are as set forth in Exhibit B.

28. BOND PROVISIONS

28.01. Pursuant to Section 2253.021 of the Texas Government Code, for all public works contracts with governmental entities, a payment bond is required if the Contract Amount exceeds \$50,000, and a performance bond is required if the Contract Amount exceeds \$100,000. Below those amounts, the City *may* require payment and/or performance bonds. In the event a performance or payment bond or both is required either by law or in the City's discretion, such bonds shall be executed in accordance with all requirements of Article 7.19-1 of the Texas Insurance Code, all other applicable law, and the following:

- (a) The Contractor shall execute performance and payment bonds for the full Contract Amount.
- (b) The bond surety shall be authorized under the laws of the State of Texas to provide a performance and payment bond and shall have attached proof of authorization of the surety to act in the performance and payment of bonds.
- (c) The Contractor shall provide original, sealed, and complete counterparts of the executed bonds in the forms required by the Contract Documents, which are attached as Exhibit C, together with valid original powers of attorney, **at the time of execution of this Agreement and prior** to the commencement of work. Copies of the executed bonds shall be attached hereto as **Exhibit C**.

- (d) The performance and payment bonds shall remain in effect for a period of one (1) year after Final Completion of the work and shall be extended for any warranty work to cover the warranty period.
- (e) If at any time during the execution of this Agreement in the required period thereafter, the bond or bonds become invalid or ineffective for any reason, the Contractor shall promptly supply within ten (10) days such other bond or bonds, which bond or bonds shall assure performance or payment as required.

28.02. The Contractor may make such changes and alterations as the City may require in the work or any part thereof without affecting the validity of this Agreement and any accompanying bond. If such changes or alterations diminish the quantity of the work to be done, they shall not constitute the basis for any claim for damages or anticipated profits. If the City makes changes or alterations that render useless any work already done or material already used in said work, then the City shall compensate the Contractor for any material or labor so used, and for any actual loss occasioned by such change due to actual expenses incurred in preparation for the work as originally planned, in accordance with the provisions of Article 17.

29. SURETY

29.01. If the Contractor has abandoned the Project or the City has terminated the contract for cause and the Contractor's Surety, after notice demanding completion is sent, fails to commence the completion of the work in compliance with this Agreement, then the City at its option may provide for completion of the work in either of the following manners:

29.01.01. The City may employ such force of men and use of instruments, machinery, equipment, tools, materials, and supplies as said the City may deem necessary to complete the work and charge the expense of such labor, machinery, equipment, tools, materials, and supplies to said the Contractor, and the expense so charged shall be deducted and paid by the City out of such monies as may be due or that may thereafter at any time become due to the Contractor and Surety.

29.01.02. The City may, after notice published as required by law, accept sealed bids and let this Agreement for the completion of the work under substantially the same terms and conditions that are provided in this Agreement. In case of any increase in cost to the City under the new agreement as compared to what would have been the cost under this Agreement, such increase together with all of the City's damages due to Contractor's abandonment and/or default, including liquidated damages, as provided pursuant to Paragraph 38, entitled "TERMINATION FOR CAUSE" shall be charged to the Contractor and the surety shall be and remain bound therefor. However, should the cost to complete such new agreement prove to be less than that which would have been the cost to complete the work under this Agreement, the Contractor shall be credited therewith after all deductions are made in accordance with this Agreement.

29.02. Should the cost to complete the work exceed the Contract Amount and the Contractor fails to pay the amount due to the City within the time designated and there remains any machinery, equipment, tools, materials, or supplies on the site of the work, notice thereof, together with an itemized list of such equipment and materials, shall be mailed to the Contractor at its respective address designated in this Agreement; provided, however, that actual written notice given in any manner shall satisfy this condition. After mailing, or otherwise giving such notice, such property shall be held at the risk of the Contractor subject only to the duty of City's Representative to exercise ordinary care to

protect such property. After fifteen (15) calendar days from the date of said notice, City's Representative may sell such machinery, equipment, tools, materials, or supplies and apply the net sum derived from such sale to the credit of the Contractor. Such sale may be made at either public or private sale, with or without notice, as City's Representative may elect. City's Representative shall release any machinery, equipment, tools, materials, or supplies which remain on the job site and belong to persons other than the Contractor to their proper owners.

29.03. In the event the account shows that the cost to complete the work is less than that which would have been the cost to City had the work been completed by the Contractor under the terms of this Agreement, or when the Contractor shall pay the balance shown to be due by them to the City, then all machinery, equipment, tools, materials, or supplies left on the site of the work shall be turned over to the Contractor.

30. COMPLIANCE WITH LAW

30.01. The Contractor's work and materials shall comply with all state and federal laws, municipal ordinances, regulations, codes, and directions of inspectors appointed by proper authorities having jurisdiction.

30.02. The Contractor shall perform and require all subcontractors to perform the work in accordance with applicable laws, codes, ordinances, and regulations of the State of Texas and the United States and in compliance with OSHA and other laws as they apply to its employees. In the event any of the conditions of the specifications violate the code for any industry, then such code conditions shall prevail.

30.03. The Contractor shall follow all applicable state and federal laws, municipal ordinances, and guidelines concerning soil erosion and sediment control throughout the Project and warranty term.

31. SAFETY PRECAUTIONS

31.01. All safety measures, policies and precautions at the site are a part of the construction techniques and processes for which the Contractor shall be solely responsible. The Contractor is solely responsible for handling and use of hazardous materials or waste, and informing employees of any such hazardous materials or waste. The Contractor shall provide copies of all hazardous materials and waste data sheets to the South Padre Island Fire Department marked "Attn.: Assistant Chief".

31.02. The Contractor has the sole obligation to protect or warn any individual of potential hazards created by the performance of the work set forth herein. The Contractor shall, at its own expense, take such precautionary measures for the protection of persons, property, and the work as may be necessary.

31.03. The Contractor shall be held responsible for all damages to property, personal injuries and/or death due to failure of safety devices of any type or nature that may be required to protect or warn any individual of potential hazards created by the performance of the work set forth herein; and when any property damage is incurred, the damaged portion shall immediately be replaced or compensated for by the Contractor at its own cost and expense.

31.04. Contractor agrees that it shall not transport to, use, generate, dispose of, or install at the Project site any Hazardous Substance (as defined in Paragraph 31.07, except in accordance with applicable Environmental Laws. Further, in performing the Work,

Contractor shall not cause any release of Hazardous Substances into, or contamination of, the environment, including the soil, the atmosphere, any water course or ground water, except in accordance with applicable Environmental Laws (as hereafter defined at Paragraph 31.07). **In the event Contractor engages in any of the activities prohibited in this Paragraph 31.04 to the fullest extent permitted by law, Contractor hereby indemnifies and holds City and all of its respective officials, agents and employees harmless from and against any and all claims, damages, losses, causes of action, suits and liabilities of every kind, including, but not limited to, expenses of litigation, court costs, punitive damages and attorneys' fees, arising out of, incidental to or resulting from the activities prohibited in this Paragraph 31.04.**

31.05. In the event Contractor encounters on the Project site any Hazardous Substance, or what Contractor may reasonably believe to be a Hazardous Substance, and which is being introduced to the Work, or exists on the Project site, in a manner violative of any applicable Environmental Laws, Contractor shall immediately stop work in the area affected and report the condition to City in writing. The Work in the affected area shall not thereafter be resumed except by written authorization of City if in fact a Hazardous Substance has been encountered and has not been rendered harmless. In the event Contractor fails to stop the Work upon encountering a Hazardous Substance at the Project site, **to the fullest extent permitted by law, Contractor hereby indemnifies and holds City and all of its officials, agents and employees harmless from and against any and all claims, damages, losses, causes of action, suits and liabilities of every kind, including, but not limited to, expenses of litigation, court costs, punitive damages and attorneys' fees, arising out of, incidental to or resulting from Contractor's failure to stop the Work.**

31.06. City and Contractor may enter into a separate agreement and/or Change Order for Contractor to remediate and/or render harmless the Hazardous Substance, but Contractor shall not be required to remediate and/or render harmless the Hazardous Substance absent such agreement. Contractor shall not be required to resume work in any area affected by the Hazardous Substance until such time as the Hazardous Substance has been remediated and/or rendered harmless.

31.07. For purposes of this Agreement, the term "Hazardous Substance" shall mean and include any element, constituent, chemical, substance, compound, or mixture, which are defined as a hazardous substance by any local, state or federal law, rule, ordinance, by-law, or regulation pertaining to environmental regulation, contamination, clean-up or disclosure, including, without limitation, The Comprehensive Environmental Response, Compensation and Liability Act of 1980 ("CERCLA"), The Resource Conservation and Recovery Act ("RCRA"), The Toxic Substances Control Act ("TSCA"), The Clean Water Act ("CWA"), The Clean Air Act ("CAA"), and the Marine Protection Research and Sanctuaries Act ("MPRSA"), The Occupational Safety and Health Act ("OSHA"), The Superfund Amendments and Reauthorization Act of 1986 ("SARA"), or other state superlien or environmental clean-up or disclosure statutes including all state and local counterparts of such laws (all such laws, rules and regulations being referred to collectively as "Environmental Laws"). It is the Contractor's responsibility to comply with this Paragraph 31.07 based on the law in effect at the time its services are rendered and to comply with any amendments to those laws for all services rendered after the effective date of any such amendments.

32. TRENCH SAFETY

The Contractor must comply with Texas law regarding trench excavation exceeding five feet in depth and in accordance with the following items:

32.01 The Contractor must comply with the requirements of Tex. Health & Safety Code Ann. §756.022-023 (Vernon 1992), as amended, and the requirements of 29 C.F.R., Sections 1926.650 through 1926.653 inclusive, "Excavation, Trenching and Shoring," of the Occupational Safety and Health Administration Standards, as amended.

32.02 The Contractor must include a separate pay item for trench safety complying with trench safety requirements, stating a unit price per linear foot of trench safety systems, as measured along the centerline of trench including manholes and other line structures.

32.03 Before beginning work on this project, the Contractor must submit to the City a complete trench safety program that complies with state and federal regulations. It is the sole duty, responsibility and prerogative of the Contractor, not the City, to determine the specific applicability of the designed trench safety systems to each field condition encountered on the project.

32.04 The Contractor must provide the City the name of the "competent person" required by OSHA standards to perform the trench safety inspections. The Contractor must make daily inspections to ensure that the systems comply with all applicable laws and regulations, and must maintain a permanent record of daily inspections available for examination by the City or other government authority.

32.05 If evidence of possible cave-ins or slides is apparent, the Contractor must cease all work in the trench and surrounding area until the necessary precautions have been taken by the Contractor to safeguard personnel entering the trench.

33. INDEMNITY

33.01. CONTRACTOR SHALL PROTECT, DEFEND, HOLD HARMLESS AND INDEMNIFY THE CITY FROM ANY AND ALL CLAIMS, DEMANDS, EXPENSES, LIABILITY OR CAUSES OF ACTION FOR INJURY TO ANY PERSON, INCLUDING DEATH, AND FOR DAMAGE TO ANY PROPERTY, TANGIBLE OR INTANGIBLE, OR FOR ANY BREACH OF CONTRACT ARISING OUT OF OR IN ANY MANNER CONNECTED WITH THE WORK DONE BY ANY PERSON UNDER THIS CONTRACT. IT IS THE INTENT OF THE PARTIES THAT THIS PROVISION SHALL EXTEND TO, AND INCLUDE, ANY AND ALL CLAIMS, CAUSES OF ACTION OR LIABILITY CAUSED BY THE CONCURRENT, JOINT AND/OR CONTRIBUTORY NEGLIGENCE OF THE CITY, AN ALLEGED BREACH OF AN EXPRESS OR IMPLIED WARRANTY BY THE CITY OR WHICH ARISES OUT OF ANY THEORY OF STRICT OR PRODUCTS LIABILITY.

33.02. The indemnifications contained in paragraphs 33.01 shall include but not be limited to the following specific instances:

(a) In the event the City is damaged due to the act, omission, mistake, fault or default of the Contractor, then the Contractor shall indemnify and hold harmless and defend the City for such damage.

(b) The Contractor shall indemnify and hold harmless and defend the City from any claims for payment for goods or services brought by any material

suppliers, mechanics, laborers, or other subcontractors.

(c) The Contractor shall indemnify and hold harmless and defend the City from any and all injuries to or claims of adjacent property owners caused by the Contractor, its agents, employees, and representatives.

(d) The Contractor shall be responsible for any damage to the floor, walls, etc., caused by the Contractor's personnel or equipment during installation.

(e) The Contractor shall also be responsible for the removal of all related debris.

(f) The Contractor shall also be responsible for subcontractors hired by it.

(g) The Contractor shall indemnify, hold harmless, and defend the City from any liability caused by the Contractor's failure to comply with applicable federal, state, or local regulations, that touch upon or concern the maintenance of a safe and protected working environment and the safe use and operation of machinery and equipment in that working environment, no matter where fault or responsibility lies.

33.03. The indemnification obligations of the Contractor under this section shall not extend to include the liability of any professional engineer, the architect, their consultants, and agents or employees of any of them arising out of (1) the preparation or approval of maps, drawings, opinions, reports, surveys, Change Orders, designs or specifications, or (2) the giving of or the failure to give directions or instructions by the professional engineer, the architect, their consultants, and agents and employees of any of them, provided such giving or failure to give is the primary cause of the injury or damage.

33.04. It is agreed with respect to any legal limitations now or hereafter in effect and affecting the validity or enforceability of the indemnification obligation under Paragraph 33.01, such legal limitations are made a part of the indemnification obligation and shall operate to amend the indemnification obligation to the minimum extent necessary to bring the provision into conformity with the requirements of such limitations, and as so modified, the indemnification obligation shall continue in full force and effect.

34. RELEASE

The Contractor assumes full responsibility for the work to be performed hereunder, and hereby releases, relinquishes, and discharges the City, its officers, agents, and employees from all claims, demands, and causes of action of every kind and character, including the cost of defense thereof, for any injury to or death of any person (whether employees of either party or other third parties) and any loss of or damage to any property (whether property of either of the parties hereto, their employees, or of third parties) that is caused by or alleged to be caused by, arising out of, or in connection with the Contractor's work to be performed hereunder. This release shall apply regardless of whether said claims, demands, and causes of action are covered in whole or in part by insurance, and in the event of injury, death, property damage, or loss suffered by the Contractor, any subcontractor, or any person or organization directly or indirectly employed by any of them to perform or furnish work on the Project, this release shall

apply regardless of whether such injury, death, loss, or damage was caused in whole or in part by the negligence of the City.

35. PERMITS AND LICENSES

The Contractor shall secure and pay for all necessary permits and licenses, governmental fees, and inspections necessary for the proper execution and completion of the work. During this Agreement term and/or period during which the Contractor is working, it shall give all notices and comply with all laws, ordinances, rules, regulations, and lawful orders of any public authority bearing on the performance of the work.

36. ROYALTIES AND LICENSING FEES

The Contractor shall pay all royalties and licensing fees. The Contractor shall hold the City harmless and indemnify the City from the payment of any royalties, damages, losses or expenses including attorney's fees for suits, claims or otherwise, growing out of infringement or alleged infringement of patents, materials and methods used in the Project. It shall defend all suits or claims for infringement of any patent rights. Further, if the Contractor has reason to believe that the design, service, process, or product specified is an infringement of a patent, it shall promptly give such information to City's Representative.

37. BREACH OF CONTRACT & DAMAGES

37.01. The City shall have the right to declare the Contractor in breach of this Agreement for cause when the City determines that this Agreement is not being performed according to its understanding of the intent and meaning of this Agreement. Such breach shall not in any way invalidate, abrogate, or terminate the Contractor's obligations under this Agreement.

37.02. Without prejudice to any other legal or equitable right or remedy that the City would otherwise possess hereunder or as a matter of law, the City upon giving the Contractor five (5) calendar days prior written notice shall be entitled to damages for breach of contract, upon but not limited to the following occurrences:

- (a) If the Contractor shall fail to remedy any default after written notice thereof from City's Representative, as City's Representative shall direct; or
- (b) If the Contractor shall fail for any reason other than the failure by City's Representative to make payments called upon when due; or
- (c) If the Contractor commits a substantial default under any of the terms, provisions, conditions, or covenants contained in this Agreement.

38. TERMINATION FOR CAUSE

Without prejudice to any other legal or equitable right or remedy that the City would otherwise possess hereunder or as a matter of law, the City upon giving the Contractor five (5) calendar days prior written notice shall be entitled to terminate this Agreement in its entirety at any time for any of the following:

38.01. If the Contractor becomes insolvent, commits any act of bankruptcy, makes a general assignment for the benefit of creditors, or becomes the subject of any proceeding

commenced under any statute or law for the relief of debtors and, after notice, fails to provide adequate assurance that it can remedy all of its defaults; or

38.02. If a receiver, trustee, or liquidator of any of the property or income of the Contractor shall be appointed; or

38.03. If the Contractor shall fail to prosecute the work or any part thereof with diligence necessary to insure its progress and completion as prescribed by the time schedules; or

38.04. If the Contractor shall fail to remedy any default within ten (10) calendar days after written notice thereof from City's Representative, as City's Representative shall direct; or

38.05. If the Contractor shall fail for any reason other than the failure by City's Representative to make payments called upon when due; or

38.06. If the Contractor abandons the Work.

38.07. If the Contractor commits a substantial default under any of the terms, provisions, conditions, or covenants contained in this Agreement.

39. TERMINATION FOR CONVENIENCE

39.01. The performance of the work may be terminated at any time in whole or, from time to time, in part, by the City for its convenience. Any such termination shall be effected by delivery to the Contractor of a written notice (notice of termination) specifying the extent to which performance of the work is terminated, and the date upon which termination becomes effective.

39.02. In the event of termination for convenience, the Contractor shall only be paid the reasonable value of the Work performed prior to the effective date of the termination notice and shall be further subject to any claim the City may have against the Contractor under other provisions of this Agreement or as a matter of law. In the event of termination for convenience, Contractor Waives and Releases any claim for lost profit, other than profit on Work performed prior to the effective date of such termination.

40. RIGHT TO COMPLETE

If this Agreement is terminated for cause, the City shall have the right but shall not be obligated to complete the work itself or by others; and to this end, the City shall be entitled to take possession of and use such equipment, without rental obligation therefor, and materials as may be on the job site, and to exercise all rights, options, and privileges of the Contractor under its subcontracts, purchase orders, or otherwise; and the Contractor shall promptly assign such rights, options, and privileges to City. If the City elects to complete the work itself or by others, pursuant to the foregoing, then the Contractor and/or Contractor's surety will reimburse City for all costs incurred by the City (including, without limitation, applicable, general, administrative expenses, field overhead, the cost of necessary equipment, materials, field labor, additional fees paid to architects, engineers, attorneys or others to assist the City in connection with the termination and liquidated damages) in completing and/or correcting work by the Contractor that fails to meet any requirement of this Agreement or the other Contract Documents.

41. CLOSE OUT

41.01. After receipt of a notice of termination, whether for cause or convenience, unless otherwise directed by City's Representative, the Contractor shall, in good faith and to the best of its ability, do all things necessary in the light of such notice to assure the efficient and proper closeout of the terminated work (including the protection of City's property). Among other things, the Contractor shall, except as otherwise directed or approved by City's Representative, do the following:

- (a) Stop the work on the date and to the extent specified in the notice of termination;
- (b) Place no further orders or subcontracts for services, equipment, or materials, except as may be necessary for completion of such portion of the work as is not terminated;
- (c) Terminate all orders and subcontracts to the extent that they relate to the performance of the work terminated by the notice of termination;
- (d) Assign to City's Representative, in the manner and to the extent directed by it, all of the right, title, and interest of the Contractor under the orders or subcontracts so terminated; in which case, City's Representative shall have the right to settle or pay any or all claims arising out of the termination of such orders and subcontracts;
- (e) With the approval of City's Representative, settle all outstanding liabilities and all claims arising out of such termination, orders, and subcontracts;
- (f) Deliver to City's Representative, when directed by City's Representative, all documents and all property, which if the work had been completed, Contractor would have been required to account for or deliver to City's Representative, and transfer title to such property to City's Representative to the extent not already transferred; and/or

42. TERMINATION CONVERSION

Upon determination of Court of competent jurisdiction that termination of the Contractor pursuant to Paragraph 38 was wrongful and/or otherwise improper, such termination will be deemed converted to a termination for convenience pursuant to Paragraph 39 and Contractor's remedy for such termination shall be limited to the recovery of the payments permitted for termination for convenience as set forth in Paragraph 39.

43. HIRING

During the term of this Agreement and for a period of one (1) year thereafter, the Contractor agrees not to solicit for hire any employee or employees of the City that were associated with work specified under this Agreement. In the event that this provision is breached by the Contractor, the Contractor agrees to pay the City damages in the amount equal to twelve (12) months of the employee's total compensation plus any legal expenses associated with enforcement of this provision.

44. ASSIGNMENT

This Agreement and the rights and obligations contained herein may not be assigned by the Contractor without the prior written approval of the City.

45. EFFECTIVE DATE

The effective date of this contract shall be the date of award of the contract.

46. OTHER TERMS

46.01. Invalidity. If any provision of this Agreement shall be held to be invalid, illegal or unenforceable by a court or other tribunal of competent jurisdiction, the validity, legality, and enforceability of the remaining provisions shall not in any way be affected or impaired thereby. The parties shall use their best efforts to replace the respective provision or provisions of this Agreement with legal terms and conditions approximating the original intent of the parties.

46.02. Written Notice. Unless otherwise specified, written notice shall be deemed to have been duly served if delivered in person to the individual or to a member of the firm or to any officer of the corporation for whom it is intended or if it is delivered or sent certified mail to the last business address as listed herein. Each party will have the right to change its business address by at least thirty (30) calendar days written notice to the other parties in writing of such change.

46.03. Entire Agreement. It is understood that this Agreement contains the entire agreement between the parties and supersedes any and all prior agreements, arrangements, or understandings between the parties relating to the subject matter. No oral understandings, statements, promises or inducements contrary to the terms of this Agreement exist. This Agreement cannot be changed or terminated orally. No verbal agreement or conversation with any officer, agent or employee of the City, either before or after the execution of this Agreement, shall affect or modify any of the terms or obligations hereunder.

46.04. Amendment. No amendment to this Agreement shall be effective and binding unless and until it is reduced to writing and signed by duly authorized representatives of both parties.

46.05. Mediation. After receipt of a Notice of Claim, the Owner may elect to refer the matter to the Architect, Owner's Representative or another party for review. Contractor will attend meetings called to review and discuss the Claims and mitigation of the problem, and shall furnish any reasonable factual backup for the Claim requested. The Owner may also elect to defer consideration of the Claim until the Work is completed, in which case the same review options shall be available to the Owner at the completion of the Work. At any stage, the Owner, at its sole discretion, is entitled to refer a Claim to mediation under the Construction Industry Mediation Rules of the American Arbitration Association, and, if this referral is made, Contractor will take part in the mediation process. The filing, mediation or rejection of a Claim does not entitle Contractor to stop performance of the Work. The Contractor shall proceed diligently with performance of the Contract during the pendency of any claim, excepting termination or under Owner's direction to stop the Work. Agreements reached in mediation shall be enforceable as settlement agreements in any court having jurisdiction thereof. The parties shall share the Mediator's fee and any filing fees equally and the Mediation shall be held in South Padre Island, Texas.

46.06. **Arbitration.** In the event of a dispute and upon the mutual written consent of both parties, the parties may agree to arbitration without waiving any of their other rights hereunder.

46.07. **Choice of Law and Place of Performance.** This Agreement has been made under and shall be governed by the laws of the State of Texas. Performance and all matters related thereto shall be in Cameron County, Texas, United States of America.

46.08. **Authority to do business.** The Contractor represents that it has a certificate of authority, authorizing it to do business in the State of Texas, a registered agent and registered office during the duration of this contract.

46.09 **Authority to Contract.** Each party has the full power and authority to enter into and perform this Agreement, and the person signing this Agreement on behalf of each party has been properly authorized and empowered to enter into this Agreement. The persons executing this Agreement hereby represent that they have authorization to sign on behalf of their respective corporations.

46.10. **Waiver.** Failure of any party, at any time, to enforce a provision of this Agreement shall in no way constitute a waiver of that provision nor in any way affect the validity of this Agreement, any part hereof, or the right of the City thereafter to enforce each and every provision hereof. No term of this Agreement shall be deemed waived or breach excused unless the waiver shall be in writing and signed by the party claimed to have waived. Furthermore, any consent to or waiver of a breach will not constitute consent to or waiver of or excuse of any other different or subsequent breach.

46.11. **Headings, Gender, Number.** The article headings are used in this Agreement for convenience and reference purposes only and are not intended to define, limit, or describe the scope or intent of any provision of this Agreement and shall have no meaning or effect upon its interpretation. Words of any gender used in this Agreement shall be held and construed to include any other gender, and words in the singular number shall be held to include the plural, and vice versa, unless the context requires otherwise.

46.12. **Agreement Read.** The parties acknowledge that they have had opportunity to consult with counsel of their choice, have read, understand and intend to be bound by the terms and conditions of this Agreement.

46.13. **Multiple Originals.** It is understood and agreed that this Agreement may be executed in a number of identical counterparts, each of which shall be deemed an original for all purposes.

46.14. **Notice of Indemnification.** City and Contractor hereby acknowledge and agree that this Agreement contains certain indemnification obligations and covenants.

[INSERT NAME OF CONTRACTOR]

CITY OF SOUTH PADRE ISLAND

By: _____
Printed Name: _____
Title: _____
Date: _____

By: _____
Mayor
Date: _____

APPROVED:

City Manager
Date: _____

City Attorney
Date: _____

EXHIBIT A
INSERT APPROPRIATE DAVIS BACON WAGE RATES

Copy and paste the following notes to the end of the DB wage rates for Building Construction or Heavy/Highway Construction.

1. Payment greater than prevailing wage rate as listed within this document not prohibited per Texas Government Code, Chapter 2258, Prevailing Wage Rates, Subchapter A. General Provisions.
2. Not less than the following hourly rates shall be paid for the various classifications of work required by this project. Workers in classifications where rates are not identified shall be paid not less than the general prevailing rate of "laborer" for the various classifications of work therein listed.
3. The hourly rate for legal holiday and overtime work shall not be less than one and one-half (1 & 1/2) times the base hourly rate.
4. The rates listed are journeyman rates. Helpers may be used on the project and may be compensated at a rate determined mutually by the worker and employer, commensurate with the experience and skill of the worker but not at a rate less than 60% of the journeyman's wage as shown. Apprentices (enrolled in a federally certified apprentice program) may be used at the percentage rates of the journeyman scale stipulated in their apprenticeship agreement. At no time shall a journeyman supervise more than two (2) apprentices or helpers. All apprentices or helpers shall be under the direct supervision of a journeyman working as a crew.

EXHIBIT B
INSURANCE REQUIREMENTS

During the term of this Agreement Contractor's insurance policies shall meet the following requirements:

I. Standard Insurance Policies Required:

- A. Commercial General Liability
- B. Business Automobile Liability
- C. Umbrella / Excess Liability – required for contract amounts exceeding \$1,000,000
- D. Workers' Compensation
- E. Builder's Risk – provides coverage for contractor's labor and materials for a project during construction that involves a structure such as a building or garage. builder's risk policy shall be written on "all risks" form.

II. General Requirements Applicable to All Policies:

- A. Only Insurance Carriers licensed and admitted to do business in the State of Texas will be accepted.
- B. Deductibles shall be listed on the Certificate of Insurance and are acceptable only on a per occurrence basis for property damage only.
- C. "Claims Made" policies are not accepted.
- D. Each insurance policy shall be endorsed to state that coverage shall not be suspended, voided, canceled, reduced in coverage or in limits except after thirty (30) days prior written notice by certified mail, return receipt requested, has been given to the City of South Padre Island.
- E. Upon request, certified copies of all insurance policies shall be furnished to the City of South Padre Island.
- F. The City of South Padre Island, its officials, employees and volunteers, are to be named as "Additional Insured" to the Commercial General, Umbrella and Business Automobile Liability policies. The coverage shall contain no special limitations on the scope of protection afforded to the City, its officials, employees or volunteers.

III. Commercial General Liability

- A. General Liability insurance shall be written by a carrier with a "A:VIII" or better rating in accordance with the current Best Key Rating Guide.
- B. Limit of \$1,000,000.00 per occurrence for bodily injury and property damage with an annual aggregate limit of \$2,000,000.00 which limits shall be endorsed to be per Project.
- C. Coverage shall be at least as broad as ISO form GC 00 01.
- D. No coverage shall be excluded from the standard policy without notification of individual exclusions being attached for review and acceptance.

- E. The coverage shall include but not be limited to the following: premises/operations with separate aggregate; independent contracts; products/completed operations; contractual liability (insuring the indemnity provided herein) Host Liquor Liability, Personal & Advertising Liability; and Explosion, Collapse, and Underground coverage.

IV. Business Automobile Liability

- A. Business Automobile Liability insurance shall be written by a carrier with a "A:VIII" or better rating in accordance with the current Best Key Rating Guide.
- B. Minimum Combined Single Limit of \$1,000,000.00 per occurrence for bodily injury and property damage.
- C. Coverage shall be at least as broad as Insurance Service's Office Number CA 00 01.
- D. The Business Auto Policy must show Symbol 1 in the Covered Autos Portion of the liability section in Item 2 of the declarations page.
- E. The coverage shall include owned autos, leased or rented autos, non-owned autos, any autos and hired autos.
- F. Pollution Liability coverage shall be provided by endorsement MCS-90, with a limit of \$1,000,000.00.

V. Excess Liability

Umbrella form excess liability coverage following the form of the underlying coverage with a minimum limit of \$5,000,000.00 or the total value of the contract, whichever is greater, per occurrence/aggregate when combined with the lowest primary liability coverage, is required for contracts exceeding \$1,000,000 in total value.

- VI. Those policies set forth in Paragraphs III, IV, and V shall contain an endorsement naming the City as Additional Insured and further providing that the Contractor's policies are primary to any self-insurance or insurance policies procured by the City. The additional insured endorsement shall be in a form at least as broad as ISO form GC 2026. Waiver of subrogation in a form at least as broad as ISO form 2404 shall be provided in favor of the City on all policies obtained by the Contractor in compliance with the terms of this Agreement. Contractor shall be responsible for all deductibles which may exist on any policies obtained in compliance with the terms of this Agreement. All coverage for subcontractors shall be subject to the requirements stated herein. All Certificates of Insurance and endorsements shall be furnished to the City's Representative at the time of execution of this Agreement, attached hereto as Exhibit D, and approved by the City before work commences.

VII. Workers Compensation Insurance

- A. Pursuant to the requirements set forth in Title 28, Section 110.110 of the Texas Administrative Code, all employees of the Contractor, all employees of any and all subcontractors, and all other persons providing services on the Project must be covered by a workers compensation insurance policy: either directly through their employer's policy (the Contractor's or subcontractor's policy) or through an executed coverage agreement on an approved Texas Department of Insurance Division of Workers Compensation (DWC) form. Accordingly, if a subcontractor

does not have his or her own policy and a coverage agreement is used, contractors and subcontractors must use that portion of the form whereby the hiring contractor agrees to provide coverage to the employees of the subcontractor. The portion of the form that would otherwise allow them not to provide coverage for the employees of an independent contractor may not be used.

- B. Workers compensation insurance shall include the following terms:
1. Employer's Liability minimum limits of \$1,000,000.00 for each accident/each disease/each employee are required.
 2. "Texas Waiver of Our Right to Recover From Others Endorsement, WC 42 03 04" shall be included in this policy.
 3. Texas must appear in Item 3A of the Workers Compensation coverage or Item 3C must contain the following: All States except those listed in Item 3A and the States of NV, ND, OH, WA, WV, and WY.
- C. Pursuant to the explicit terms of Title 28, Section 110.110(c) (7) of the Texas Administrative Code, the bid specifications, this Agreement, and all subcontracts on this Project must include the following terms and conditions in the following language, without any additional words or changes, except those required to accommodate the specific document in which they are contained or to impose stricter standards of documentation:

"A. Definitions:

Certificate of coverage ("certificate") – An original certificate of insurance, a certificate of authority to self-insure issued by the Division of Workers Compensation, or a coverage agreement (DWC-81, DWC-83, or DWC-84), showing statutory workers' compensation insurance coverage for the person's or entity's employees providing services on a project, for the duration of the project.

Duration of the project - includes the time from the beginning of the work on the project until the Contractor's/person's work on the project has been completed and accepted by the governmental entity.

Persons providing services on the project ("subcontractors" in § 406.096 [of the Texas Labor Code]) - includes all persons or entities performing all or part of the services the Contractor has undertaken to perform on the project, regardless of whether that person contracted directly with the Contractor and regardless of whether that person has employees. This includes, without limitation, independent Contractors, subcontractors, leasing companies, motor carriers, owner-operators, employees of any such entity, or employees of any entity which furnishes persons to provide services on the project. "Services" include, without limitation, providing, hauling, or delivering equipment or materials, or providing labor, transportation, or other service related to a project. "Services" does not include activities unrelated to the project, such as food/beverage vendors, office supply deliveries, and delivery of portable toilets.

- B. *The Contractor shall provide coverage, based on proper reporting of classification codes and payroll amounts and filing of any coverage agreements, that meets the statutory requirements of Texas Labor Code, Section 401.011(44) for all employees of the Contractor providing services on the project, for the duration of the project.*

- C. *The Contractor must provide a certificate of coverage to the governmental entity prior to being awarded the contract.*
- D. *If the coverage period shown on the Contractor's current certificate of coverage ends during the duration of the project, the Contractor must, prior to the end of the coverage period, file a new certificate of coverage with the governmental entity showing that coverage has been extended.*
- E. *The Contractor shall obtain from each person providing services on a project, and provide to the governmental entity:*
 - (1) *a certificate of coverage, prior to that person beginning work on the project, so the governmental entity will have on file certificates of coverage showing coverage for all persons providing services on the project; and*
 - (2) *no later than seven calendar days after receipt by the Contractor, a new certificate of coverage showing extension of coverage, if the coverage period shown on the current certificate of coverage ends during the duration of the project.*
- F. *The Contractor shall retain all required certificates of coverage for the duration of the project and for one year thereafter.*
- G. *The Contractor shall notify the governmental entity in writing by certified mail or personal delivery, within 10 calendar days after the Contractor knew or should have known, or any change that materially affects the provision of coverage of any person providing services on the project.*
- H. *The Contractor shall post on each project site a notice, in the text, form and manner prescribed by the Division of Workers Compensation, informing all persons providing services on the project that they are required to be covered, and stating how a person may verify coverage and report lack of coverage.*
- I. *The Contractor shall contractually require each person with whom it contracts to provide services on a project, to:*
 - (1) *provide coverage, based on proper reporting of classification codes and payroll amounts and filing of any coverage agreements, that meets the statutory requirements of Texas Labor Code, Section 401.011(44) for all of its employees providing services on the project, for the duration of the project;*
 - (2) *provide to the Contractor, prior to that person beginning work on the project, a certificate of coverage showing that coverage is being provided for all employees of the person providing services on the project, for the duration of the project;*
 - (3) *provide the Contractor, prior to the end of the coverage period, a new certificate of coverage showing extension of coverage, if the coverage period shown on the current certificate of coverage ends during the duration of the project;*
 - (4) *obtain from each other person with whom it contracts, and provide to the*

Contractor:

- (a) A certificate of coverage, prior to the other person beginning work on the project; and*
 - (b) A new certificate of coverage showing extension of coverage, prior to the end of the coverage period, if the coverage period shown on the current certificate of coverage ends during the duration of the project;*
 - (5) retain all required certificates of coverage on file for the duration of the project and for one year thereafter;*
 - (6) notify the governmental entity in writing by certified mail or personal delivery, within 10 calendar days after the person knew or should have known, of any change that materially affects the provision of coverage of any person providing services on the project; and*
 - (7) Contractually require each person with whom it contracts to perform as required by paragraphs (a) - (g), with the certificates of coverage to be provided to the person for whom they are providing services.*
- J. By signing this contract, or providing, or causing to be provided a certificate of coverage, the Contractor is representing to the governmental entity that all employees of the Contractor who will provide services on the project will be covered by workers' compensation coverage for the duration of the project; that the coverage will be based on proper reporting of classification codes and payroll amounts; and that all coverage agreements will be filed with the appropriate insurance carrier or, in the case of a self-insured, with the Commission's Division of Self-Insurance Regulation. Providing false or misleading information may subject the Contractor to administrative penalties, criminal penalties, civil penalties, or other civil actions.*
- K. The Contractor's failure to comply with any of these provisions is a breach of contract by the Contractor that entitles the governmental entity to declare the contract void if the Contractor does not remedy the breach within ten calendar days after receipt of notice of breach from the governmental entity."*
- VIII. Certificates of Insurance shall be prepared and executed by the insurance company or its authorized agent, and shall contain the following provisions and warranties:
- A. The company is licensed and admitted to do business in the State of Texas.
 - B. The insurance policies provided by the insurance company are underwritten on forms that have been provided by the Texas State Board of Insurance or ISO.
 - C. All endorsements and insurance coverages according to requirements and instructions contained herein.
 - D. The form of the notice of cancellation, termination, or change in coverage provisions to the City of South Padre Island.
 - E. Original endorsements affecting coverage required by this section shall be

furnished with the certificates of insurance.

EXHIBIT C
PERFORMANCE AND PAYMENT BONDS

PERFORMANCE BOND
No. _____

Project _____

THE STATE OF TEXAS §
 §
THE COUNTY OF CAMERON §

KNOW ALL MEN BY THESE PRESENTS:

THAT WE, _____, as Principal, hereinafter called "Contractor" and the other subscriber hereto _____, as Surety, do hereby acknowledge ourselves to be held and firmly bound to the City of South Padre Island, a municipal corporation, in the sum of _____ (\$ _____) for the payment of which sum, well and truly to be made to the City of South Padre Island and its successors, the said Contractor and Surety do bind themselves, their heirs, executors, administrators, successors, and assigns, jointly and severally.

THE CONDITIONS OF THIS OBLIGATION ARE SUCH THAT:

WHEREAS, the Contractor has on or about this day executed a Contract in writing with the City of South Padre Island for

_____ all of such work to be done as set out in full in said Contract Documents therein referred to and adopted by the City Council, all of which are made a part of this instrument as fully and completely as if set out in full herein.

NOW THEREFORE, if the said Contractor shall faithfully and strictly perform Contract in all its terms, provisions, and stipulations in accordance with its true meaning and effect, and in accordance with the Contract Documents referred to therein and shall comply strictly with each and every provision of the Contract, including all warranties and indemnities therein and with this bond, then this obligation shall become null and void and shall have no further force and effect; otherwise the same is to remain in full force and effect.

It is further understood and agreed that the Surety does hereby relieve the City of South Padre Island or its representatives from the exercise of any diligence whatever in securing compliance on the part of the Contractor with the terms of the Contract, including the making of payments thereunder and, having fully considered its Principal's competence to perform the Contract in the underwriting of this Performance Bond, the Surety hereby waives any notice to it of any default, or delay by the Contractor in the performance of his Contract and agrees that it, the Surety, shall be bound to take notice of and shall be held to have knowledge of all acts or omissions of the Contractor in all matters pertaining to the Contract. The Surety understands and agrees that the provision in the Contract that the City of South Padre Island shall retain certain amounts due the Contractor until the expiration of thirty days from the acceptance of the Work is intended for the City's benefit, and the City of South Padre Island shall have the right to

pay or withhold such retained amounts or any other amount owing under the Contract without changing or affecting the liability of the Surety hereon in any degree.

It is further expressly agreed by Surety that the City of South Padre Island or its representatives are at liberty at any time, without notice to the Surety, to make any change in the Contract Documents and in the Work to be done thereunder, as provided in the Contract, and in the terms and conditions thereof, or to make any change in, addition to, or deduction from the work to be done thereunder; and that such changes, if made, shall not in any way vitiate the obligation in this bond and undertaking or release the Surety therefrom.

It is further expressly agreed and understood that the Contractor and Surety will fully indemnify and hold harmless the City of South Padre Island from any liability, loss, cost, expense, or damage arising out of or in connection with the work done by the Contractor under the Contract. In the event that the City of South Padre Island shall bring any suit or other proceeding at law on the Contract or this bond or both, the Contractor and Surety agree to pay to the City the actual amounts of attorneys' fees incurred by the city in connection with such suit.

This bond and all obligations created hereunder shall be performable in Cameron County, Texas. This bond is given in compliance with the provisions of Chapter 2253 of the Texas Government Code, as amended, which is incorporated herein by this reference. However, all of the express provisions hereof shall be applicable whether or not within the scope of said statute.

Notices required or permitted hereunder shall be in writing and shall be deemed delivered when actually received or, if earlier, on the third day following deposit in a United State Postal Service post office or receptacle, with proper postage affixed (certified mail, return receipt requested), addressed to the respective other party at the address prescribed in the Contract Documents, or at such other address as the receiving party may hereafter prescribe by written notice to the sending party.

IN WITNESS THEREOF, the said Contractor and Surety have signed and sealed this instrument on the respective dates written below their signatures and have attached current Power of Attorney.

ATTEST and SEAL: (if a corporation)

(Name of Contractor)

WITNESS: (if not a corporation)

By: _____

By: _____

Name:
Title:
Date:

Name:
Title:
Date:

ATTEST/WITNESS (SEAL)

(Full Name of Surety)

By: _____
Name:
Title:
Date:

(Address of Surety for Notice)

By: _____
Name: _____
Title: _____
Date: _____

REVIEWED:

THE FOREGOING BOND IS ACCEPTED
ON BEHALF OF
THE CITY OF SOUTH PADRE ISLAND,
TEXAS:

City Attorney's Office

City Manager

NOTE: Date of bonds must be equal to or after the date of execution by City.

TEXAS STATUTORY PAYMENT BOND

Project No. _____

THE STATE OF TEXAS §

§

KNOW ALL MEN BY THESE PRESENTS:

THE COUNTY OF CAMERON §

THAT WE, _____, as Principal, hereinafter called "Principal" and the other subscriber hereto _____, a corporation organized and existing under the laws of the State of _____, licensed to business in the State of Texas and admitted to write bonds, as Surety, herein after called "Surety", do hereby acknowledge ourselves to be held and firmly bound to the City of South Padre Island, a municipal corporation, in the sum of _____ (\$_____) for payment whereof, the said Principal and Surety bind themselves, and their heirs, administrators, executors, successors and assigns jointly and severally.

THE CONDITIONS OF THIS OBLIGATION ARE SUCH THAT:

WHEREAS, Principal has entered into a certain contract with the City of South Padre Island, dated the ____ day of _____, 200__, for _____

_____, which contract is hereby referred to and made a part hereof as fully and to the same extent as if copied at length herein.

NOW THEREFORE, the condition of this obligation is such that if Principal shall pay all claimants supplying labor and material to him or a subcontractor in the prosecution of the work provided for in said contract, then, this obligation shall be null and void; otherwise to remain in full force and effect;

PROVIDED, HOWEVER, that this bond is executed pursuant to the provisions of Chapter 2253 of the Texas Government Code and all liabilities on this bond shall be determined in accordance with the provisions, conditions and limitations of said Code to the same extent as if it were copied at length herein.

IN WITNESS THEREOF, the said Principal and Surety have signed and sealed this instrument on the respective dates written below their signatures.

ATTEST and SEAL: (if a corporation)

(Name of Contractor)

WITNESS: (if not a corporation)

By: _____

Name:
Title:
Date:

By: _____

Name:
Title:
Date:

ATTEST/WITNESS (SEAL)

(Full Name of Surety)

By: _____

Name:
Title:
Date:

(Address of Surety for Notice)

By: _____

Name: _____
Title: _____
Date: _____

REVIEWED:

THE FOREGOING BOND IS ACCEPTED
ON BEHALF OF
THE CITY OF SOUTH PADRE ISLAND,
TEXAS:

City Attorney's Office

City Manager

NOTE: Date of bonds must be equal to or after the date of execution by City.

EXHIBIT D
CERTIFICATES OF INSURANCE AND ENDORSEMENTS

EXHIBIT E
TECHNICAL SPECIFICATIONS AND PLANS

TABLE OF CONTENTS
TECHNICAL SPECIFICATIONS

City of South Padre Island Standard Specifications

2.04 Clearing, Grubbing, Excavation, and Embankment.....	2
2.05 Subgrade.....	4
2.06 Base Course	6
2.07 Bituminous Pavement (Hot Asphalt Concrete).....	7
2.08 Hydraulic Cement Concrete.....	10
2.09 Pavement Markings, Street Signs, and Traffic Control Devices	15
2.10 Finishing Shoulders, Ditches, and Slope	17
2.12 Curbs and Gutters	18
2.13 Sidewalks	20
2.14 Driveways, Alleys, Entrances, and Approaches	22
2.16 Backfill and Compaction	24
2.19 Valley Gutters	24
5.03 Stormwater Sewer System Specifications	25
Article 6 – Barricades and Channelizing Devices	39

Project Specifications

PS-01 Stamped Thermoplastic Pavement Marking	40
PS-02 Composite Inlet & Manhole Ring and Cover.....	43

TxDOT Standard Specifications (Available as 2014 Standard Specification Book at <https://www.txdot.gov/business/resources/txdot-specifications.html>)

The following specifications are included in this contract. TxDOT Standard Specifications that have been identified for use in this project are listed below. Any other TxDOT documents referenced in the TxDOT Standards are included in the contract by reference.

Item 275	Cement Treatment (Road-Mixed)
Item 440	Reinforcement for Concrete
Item 465	Junction Boxes, Manholes, and Inlets
Item 471	Frames, Grates, Rings, and Covers
Item 481	Pipe for Drains
Item 531	Sidewalk



2.04 Clearing, Grubbing, Excavation, and Embankment:

- A. Description: This section shall regulate the clearing, grubbing, removing, and disposing of all vegetation and debris within the construction limits of the project, except such objects as are designated to remain or are to be removed in accordance with other articles of these standards and specifications. This section shall also regulate the excavation, hauling, disposal, stripping and stockpiling of top soil, compaction of material, and all other earthwork for the construction of the roadway, side ditches, and swales, in accordance with the approved engineering plans. Additional specifications as required under a Beach and Dune Construction Permit shall also apply in the event such permit is required and issued.
- B. General: All areas, as shown on the plans, shall be cleared of all structures and obstructions. Those trees and shrubs and other landscape features specifically designated by the Public Works Director for preservation shall be carefully marked and protected from abuse, marring, or damage during construction operations. Continual parking and/or servicing of equipment under the branches of trees marked for preservation will not be permitted. Any damage to natural terrain or to vegetation or objects designated to remain shall be repaired, replaced, or otherwise compensated for as determined by the Public Works Director. The excavation and embankments for the roadway, and all other earthwork shall be finished to reasonably smooth and uniform surfaces. Erosion during and after construction shall be controlled by methods established under City Standards and Specifications Article 7 - Erosion and Sediment Control.
- C. Drainage Structures: Culverts, storm sewers, manholes, and inlets shall be removed in proper sequence for maintenance of traffic and drainage. All structures shall be replaced by methods established under Article 5 - Stormwater Drainage.
- D. Underground Obstructions: Underground obstructions, except those items designated for preservation, shall be removed to the following depths:
- (1) In areas to receive embankments: Two (2) feet below natural ground, except when permitted by the plans, trees and stumps may be cut off as close to natural ground as practicable on areas which are to be covered by at least three (3) feet of embankment.
 - (2) In areas to be excavated: Two (2) feet below the lower elevation of the excavation.
 - (3) All other areas: One (1) foot below natural ground.
- E. Disposal of Material: Unless otherwise shown herein, all materials and debris removed shall become the property of the contractor, including all merchantable timber, and shall be removed from the site and disposed of by a permitted solid waste hauler or state certified hauler or in a manner satisfactory to the Public Works Director. NOTE - No on-site burning will be allowed.
- F. Top Soil: The contractor shall remove and stockpile all top soil within the limits of the roadway and earthwork construction areas. The top soil shall be stockpiled on the site and re-distributed over those areas that will be seeded and/or sodded at the completion of the earthwork

- G. Backfill: Holes remaining after removal of all obstructions, objectionable material, trees, stumps, and so forth, shall be backfilled with approved material, compacted, and restored to its original contours by blading, bulldozing, or by other methods, as approved by the Public Works Director. Before backfilling, the remaining ends of all abandoned storm sewers, conduits, culverts, sanitary sewers, and water or gas pipes shall be plugged in a manner approved by the appropriate utility agency or the Public Works Director.
- H. Sand: All sand material removed from existing dunes located within the City limits shall remain within the City limits and in areas approved by the Public Works Director.
- I. Specification: Except as they may be superseded by these standards and specifications, the specifications for clearing, grubbing, excavation, and embankment shall conform to the requirements of the following sub-sections of the Texas Department of Transportation's Standard Specifications for Construction of Highways, Streets, and Bridges (current edition):

Division I, Earth Work and Landscape

Item 100	Preparing Right-of-Way
Item 103	Disposal of Wells
Item 104	Removing Concrete
Item 105	Removing Stabilized Base and/or Asphaltic Pavement
Item 106	Obliterating Abandoned Road
Item 110	Excavation
Item 112	Subgrade Widening
Item 132	Embankment
Item 134	Backfilling Pavement Edges
Item 150	Blading
Item 152	Road Grader Work
Item 154	Scraper Work
Item 156	Bulldozer Work
Item 158	Specialized Excavation Work
Item 160	Top Soil
Item 162	Sodding for Erosion Control
Item 164	Seeding for Erosion Control
Item 166	Fertilizer
Item 168	Vegetative Watering
Item 169	Soil Retention Blanket
Item 170	Irrigation System
Item 180	Wildflower Seeding
Item 192	Landscape Planting
Item 193	Landscape Establishment

2.05 Subgrade:

A. Description: This section regulates the preparation and construction of that part of the road bed below the proposed road materials. Subgrade construction shall be in close conformance to the lines, grades, and cross-sections shown on the approved engineering plans, or as may subsequently be established by the Public Works Director.

B. Construction Requirements:

- (1) The subgrade material shall be brought to a firm and unyielding condition with a uniform density. All soft and yielding material that will not compact readily when rolled or tamped shall be removed and replaced with suitable material. Paving material shall not be placed on soft, spongy, or otherwise unsuitable subgrade. In areas having poor soil conditions, subgrade stabilization shall be required to meet the needs of this section.
- (2) Unless otherwise provided, the roadbed below the subgrade shall be so constructed that it will have, as nearly as possible, a uniform density throughout. In both cuts and fills, it shall be rolled with a 3-wheel roller weighing no less than ten (10) tons, or with other approved compacting equipment capable of providing a smooth, even subgrade surface. In areas not accessible to the roller or other equipment, the required compaction shall be obtained with mechanical tamps or vibrators.
- (3) Unless otherwise provided, the first six (6) inches below the subgrade shall be compacted to at least the ninety-five (95) percent of the maximum density as determined by the Modified Proctor Test.
- (4) During subgrade preparation, and after its completion, adequate drainage shall be provided at all times to prevent water from standing on the subgrade. In no case shall paving material be placed upon the subgrade when the subgrade is muddy or unstable. No hauling shall be done nor equipment moved over the subgrade when its condition is such that undue distortion results, unless the subgrade is protected with adequate plank runways, mats, or other satisfactory means approved by the Public Works Director.
- (5) A leveling course is not required as long as the finished subgrade conforms to the lines, grades, and cross-sections of the approved engineering plans, and is firm and unyielding with a uniform density. However, if a leveling course becomes necessary, it shall be of suitable compacted material.
- (6) Prior to the placement of paving materials, proof rolling of the subgrade shall be required as evidence that the subgrade is in a firm and unyielding condition, and constructed with a uniform density. In the event that the subgrade, including any portion of the construction of an embankment or any cut required to meet the proposed subgrade, does not meet with the above described compaction requirement to the satisfaction of the Public Works Director, it shall be the responsibility of the contractor to prove that the ninety-five (95) percent compaction has been achieved.

C. Specification: Except as they may be superseded by these standards and specifications, the specifications for subgrade preparation and construction shall conform to the requirements of the following sub-sections of the current Texas Department of Transportation's Standard

Specifications for Construction of Highways, Streets, and Bridges (current edition):

Division II, Subgrade Treatments and Base

Item 204	Sprinkling
Item 210	Rolling
Item 216	Rolling (Proof)
Item 260	Lime Treatment (Road Mixed)
Item 263	Lime Treatment (Plant Mixed)
Item 265	Fly Ash or Lime – Fly Ash Treatment (Road Mixed)
Item 275	Cement Treatment (Road Mixed)

2.06 Base Course:

- A. Description: This section regulates construction of the foundation course of selected material placed and compacted as a base upon the prepared subgrade. Base course construction shall be in close conformance to the lines, grades, and cross-sections shown on the approved engineering plans, or as may subsequently be established by the Public Works Director.

- B. Construction Requirements:
 - (1) Subgrade Preparation: Subgrade upon which the base course is to be placed shall be prepared as set out in Section 2.05.

 - (2) Spreading: If the required thickness of the base course exceeds seven (7) inches, the material shall be placed in two or more layers as directed. Traffic of any kind will not be permitted on the base course if it causes displacement of the material or mixing with the subgrade.

 - (3) Compacting: Stone or gravel base material for each lift, after spread and shaped, shall be compacted to a minimum one hundred (100) percent of the maximum dry density as determined in accordance with AASHTO T 99. An approved vibrating device shall be used. It may be supplemented by a 10-ton, 3-wheel tandem, or pneumatic tire roller. The contractor shall use such construction procedures, including sufficient wetting and number of passes with the vibrator to insure that the above density is attained. In the event subsequent courses are flexible, the base course shall be proof rolled prior to the placing of the next course. Any roller marks, irregularities, or failures shall be corrected as directed.

 - (4) Surface Requirements: At the time paving materials are to be placed on the base, the base shall meet the required density as set out herein, and also the surface tolerance for subgrade as required by these standards and specifications for the kind of pavement to be placed thereon.

- C. Specification: Except where they may be otherwise superseded by these standards and specifications, the specifications for base course preparation and construction shall conform to the requirements of the following sub- sections of the current Texas Department of Transportation's Standard Specifications for Construction of Highways, Streets, and Bridges (current edition):

Division II, Subgrade Treatments and Base

Item 204	Sprinkling
Item 210	Rolling
Item 216	Rolling (Proof)
Item 247	Flexible Base
Item 251	Reworking Base Courses
Item 260	Lime Treatment (Road Mixed)
Item 263	Lime Treatment (Plant Mixed)
Item 265	Fly Ash or Lime – Fly Ash Treatment (Road Mixed)
Item 275	Cement Treatment (Road Mixed)
Item 276	Cement Treatment (Plant Mixed)
Item 292	Asphalt Treatment (Plant Mixed)

2.07 Bituminous Pavement (Hot Asphalt Concrete):

- A. Description: This section regulates the construction of one or more courses of hot asphalt concrete pavement as either a base, binder, wedge, leveling, or surface course on a prepared base in accordance with these standards and specifications, and in close conformance with the lines, grades, thickness, and typical cross-sections reflected on the approved engineering plans, or as may subsequently be established by the Public Works Director.
- B. Job Mix Formula: A job mix formula for the various bituminous mixtures for the project shall be furnished by the contractor. No mixture will be accepted until the job mix formula has been approved and signed by the Public Works Director. The job mix formula will specify:
- (1) The type of bituminous mixture.
 - (2) The type and size of the aggregates (smooth, round river wash aggregates are not allowed).
 - (3) The percent of manufactured fine aggregate, when required.
 - (4) The type and grade of bitumen.
 - (5) The percentage of bitumen (based on total weight of the mixture exclusive of water or solvents).
 - (6) The percentage of aggregate passing the No. 4 sieve (based on the total weight of the aggregate).
 - (7) The mix temperature of the plant, both minimum and maximum.

The following provisions shall prevail in the administration of the job mix formula:

Variations from the job mix formula will be permitted as noted. The total percent passing the No. 4 sieve may vary ± 3.0 percentage points. The bitumen may vary ± 0.3 percentage points. Variations beyond these limits will be investigated and the contractor required to correct the conditions causing them.

If analysis shows a variation of ± 5.0 percentage points in the total passing the No. 4 sieve, ± 0.5 percentage points in the bitumen, or a gradation not in accordance with the specified mix composition, it will be cause for discontinuance of the work until the nonconformance has been corrected. One or any combination of such variations may be cause for ordering removal of the material and replacement with acceptable material at the expense of the contractor.

Sampling and testing of the final mixture shall be at least once during each day of placing bituminous mixtures, or at the request of the Public Works Director. Certified results of each day's testing shall be made available to the Public Works Director within twenty-four (24) hours.

- C. Conditioning of Existing Surfaces: When the surface of the existing pavement or old base is irregular, it shall be brought to uniform grade and cross-section as directed by the Public Works Director. When shown on plans, or directed by the Public Works Director, all longitudinal and transverse joints and all cracks shall be sealed by the application of an approved joint sealing compound before spreading the mixture upon a Hydraulic Cement concrete surface. Contact

surface or curbing, gutters, manholes, and other structures shall be painted with a thin, uniform coating of bituminous material prior to the bituminous mixture being placed against them.

- D. Preparation of Subgrade or Base: Mixtures for base may be placed upon an earth subgrade or and existing pavement surface to be used as a base, or on a prepared base or subgrade as specified in the approved engineering plans. Preparation of the subgrade or base shall closely conform to the lines, grades, and cross-sections reflected on the approved engineering plans, or as subsequently identified by the Public Works Director. Just prior to placing the initial hot asphalt base course, the area upon which it is to be placed shall be proof-rolled with a pneumatic tire roller. Proof-rolling will not be required on resurfacing or widening and other areas inaccessible to the roller. Any roller marks, irregularities or failures shall be corrected as directed by the Public Works Director.
- E. Prime Coat: Priming shall conform to the applicable provisions of the Texas Department of Transportation's Standard Specifications for construction of Highways, Streets, and Bridges (current edition).
- F. Tack Coat: The tack coat on base or binder shall conform to the applicable provisions of the Texas Department of Transportation's Standard Specifications for Construction of Highways, Streets, and Bridges (current edition).
- G. Spreading Mixtures: Any surface on which a mixture is spread shall be free from objectionable or foreign material at the time of spreading. Base, binder, wedge, and leveling courses shall be allowed to cure before being subjected to traffic or before a subsequent course is placed thereon. If the required depth of any course is to exceed three (3) times the top size of the aggregate used as shown by actual screen analysis, the course shall be constructed in two or more lifts. At locations where it is impractical to use conventional mechanical methods, other acceptable mechanical methods or acceptable hand methods may be used for placing and spreading upon approval by the Public Works Director.
- H. Compacting: There shall be operated with each spreader at least two rollers. The initial compaction shall be performed with a 10-ton, 3-wheel roller, subsequent compaction and finish rolling shall be performed with an approved tandem roller. No mixture shall be dispatched from the plant so late in the day that it cannot be spread and compacted in daylight of the same day. A sufficient number of rollers shall be used to permit compaction to be completed within thirty (30) minutes of the time the bituminous mixture has been spread. However, in any case, compaction shall be completed before the temperature of the mixture drops below one hundred and eighty (180) degrees Fahrenheit. When rolling adjacent lanes, the roller shall compress the joint by starting partially in the cold lane and lapping from six (6) to ten (10) inches over the hot material.
- I. Specification: Except as they may be otherwise superseded by these standards and specifications, the specifications for the preparation and construction of bituminous pavement shall conform to the requirements of the following sub-sections of the Texas Department of Transportation's Standard Specifications for Construction of Highways, Streets, and Bridges (current edition):

Division III, Surface Courses and Pavement

- Item 300 Asphalts, Oils, and Emulsions
- Item 301 Asphalt Antistripping Agents

Item 302	Aggregates for Surface Treatments
Item 303	Aggregates for Surface Treatments (Lightweight)
Item 305	Salvaging, Hauling, and Stockpiling Reclaimable Asphaltic Pavement
Item 310	Prime Coat
Item 314	Emulsified Asphalt Treatment
Item 315	Fog Seal
Item 316	Surface Treatments
Item 318	Hot Asphalt-Rubber Surface Treatments
Item 330	Limestone Rock Asphalt Pavement
Item 334	Hot Mix-Cold Laid Asphaltic Concrete Pavement
Item 340	Dense-Graded Hot-Mix Asphalt (Method)
Item 341	Dense-Graded Hot-Mix Asphalt (QC/QA)
Item 342	Permeable Friction Course (PFC)
Item 351	Flexible Pavement Structure Repair
Item 354	Planing and Texturing Pavement
Item 356	Fabric Underseal
Item 358	Asphaltic Concrete Surface Rehabilitation

- (4) Curing Material: Material for curing concrete shall meet the requirements of the following specifications:

Liquid Membrane-Forming Compound	ASTM C309
Waterproof Paper	ASTM C171
Polyethylene Sheeting	ASTM C171
Burlap Cloth	AASHO M182
Cotton Mats	AASHO M73

- C. Mixing and Hauling: Ready-mixed concrete shall meet the requirements of ASTM Specification C94, "Specifications for Ready-Mixed Concrete." The concrete plant shall have a current "Certificate of Conformance for Concrete Production Facilities," issued by the National Ready-Mixed Concrete Association.

D. Forming:

- (1) Setting Forms: The subgrade or base under the forms shall be compacted and cut to grade so that the forms, when set, will be at the required elevation. Forms shall be of such cross-section and strength, and so secured, as to resist the pressure of the concrete when placed, and the impact and vibration of any equipment which they support, without springing or settlement. The method of connection between the sections shall be such that the joints shall not move in any direction. The maximum deviation of the top surface shall not exceed 1/8 inch in ten (10) feet, or the inside face not more than 1/4 inch in ten (10) feet from a straight line. The contractor shall check and correct alignment and grade elevations of the forms immediately before placing the concrete. When any form has been disturbed or any grade has become unstable, the form shall be re-set and re-checked. Forms shall be capable of being removed without excessive damage to the concrete pavement.
- (2) Slipform Paving: As an alternative to using fixed forms, a slipform paver may be used, providing the surface of the pavement does not exceed the required tolerance. If any traffic is allowed to use the prepared subgrade or base, the subgrade or base shall be checked and corrected immediately ahead of placing the concrete.

E. Placing, Finishing, and Texturing:

- (1) Placing: The concrete shall be deposited on the subgrade or base so as to require as little rehandling as possible. Necessary hand spreading shall be done with shovels, not rakes. Workmen shall not be allowed to walk in the plastic concrete with boots or shoes coated with earth or foreign substances. Placing shall be continuous between transverse joints without the use of intermediate bulkheads.
- (2) Strike-Off, Consolidation, Finishing, and Texturing: The sequence of operations shall be the strike-off and consolidation, joint forming and floating, straight edging, and texturing.
- (a) The pavement shall be struck off and consolidated with a mechanical finishing machine, vibrating screed, or hand finishing methods when approved by the Public Works Director. A slipform paver may also be used.
- (b) The concrete shall be adequately consolidated; however, vibrators shall not be operated

longer than ten (10) seconds in any one location.

(c) After the pavement has been struck off and consolidated, and joints formed, it shall be scraped with a ten (10) foot long straight-edge having a handle to permit operation from the edge of the pavement. Any excess water and laitance shall be removed from the surface of the pavement. The straight-edge shall be operated at ninety (90) degrees to the transverse joints and shall be moved forward one-half of its length after each pass. Irregularities shall be corrected by adding or removing concrete. All disturbed places shall again be straight-edged. The use of wood floats shall be kept to a minimum; they may only be used in areas not accessible to finishing equipment and for compacting concrete in the vicinity of formed joints.

(d) In general, adding water to the surface of the concrete to assist in finishing operations shall not be permitted. If the Public Works Director should permit it, it shall be applied as a fog spray with approved spray equipment.

(e) A burlap bag or broom shall be used for texturing. If a burlap drag is used, it shall be at least three (3) feet wide, and long enough to cover the entire pavement width. It shall be kept clean and saturated while in use. It shall be laid on the pavement surface and dragged in the direction in which the pavement is being placed. If a broom is used, brooming shall generally be parallel to transverse joints if these are formed, and at ninety (90) degrees to the direction of paving if transverse joints are sawed.

(f) Before texturing is completed, and before the concrete has taken its initial set, the slab, curb, and formed joints shall be finished with an edger, as reflected on the approved engineering plans.

F. Curing: Concrete shall be cured by protecting it against loss of moisture, rapid temperature change, and mechanical injury for at least three (3) days after placement. White liquid membrane-forming compound, waterproof paper, white polyethylene sheeting, moist curing, or a combination of these, as reflected on the approved engineering plans, may be used.

(1) Generally, white liquid membrane-forming compound shall be used, and it shall be applied to the pavement surface immediately after the completion of the texturing operation. The compound shall also be applied to the pavement edges immediately after the forms have been removed. An application rate of one (1) gallon per two hundred (200) square feet shall be used.

(2) The compound shall be kept agitated to prevent the pigment from settling.

(3) The contractor shall have the equipment needed for adequate curing available before commencing concrete placement.

G. Pavement Protection: The contractor shall be responsible for concrete placed during rain or low temperatures. Any concrete damaged by rain or low temperatures shall be removed and replaced at the contractor's expense.

H. Joints: Contraction joints, expansion joints, and longitudinal joints shall be placed as indicated on the approved engineering plans. Transverse construction joints shall be used as required. Transverse joints shall extend continuously through the pavement and curb. Longitudinal joints

are those joints parallel to the construction lane.

(1) Transverse Contraction Joints: Transverse contraction joints shall consist of weakened planes made by forming or sawing grooves in the surface of the pavement. They shall be equal to at least one fourth the depth of the slab.

(a) Formed transverse contraction joints shall be made by:

(i) Installing an approved insert in the plastic concrete. The insert shall be installed at ninety (90) degrees to, and within 1/8 inch of the pavement surface, or

(ii) Depressing an approved tool or device into the plastic concrete. The tool or device shall remain in place until the concrete has attained its initial set, and then shall be removed without disturbing the adjacent concrete.

(b) Sawed transverse contraction joints shall be made by sawing grooves having a 1/4 inch maximum width in the surface of the pavement. After each joint is sawed, the adjacent concrete surface shall be cleaned. Sawing of the joints shall begin as soon as the concrete has hardened sufficiently to permit sawing without excessive raveling.

(c) All joints shall be sawed before uncontrolled shrinkage cracking occurs. If necessary, the sawing operations shall be carried on both day and night, regardless of weather conditions. A standby saw shall be available in the event of a breakdown. The sawing of any joint shall be omitted if a crack occurs at or near the joint location before the time of sawing. In general, all joints shall be sawed in sequence. All contraction joints in lanes adjacent to previously constructed lanes shall be sawed before uncontrolled cracking occurs. If extreme conditions make it impractical to prevent erratic cracking by timely sawing, contraction joints shall be formed before initial set of the concrete as provided above.

(d) The length between transverse contraction joints shall not exceed fifteen (15) feet, and in no case shall be less than ten (10) feet. Transverse contraction joints shall be placed at every catch basin, inlet, or manhole in the line of pavement.

(2) Transverse Construction Joints: Transverse construction joints shall be used only when approved by the Public Works Director whenever the placing of concrete is suspended and initial set may occur.

(3) Expansion Joints: The preformed joint filler shall be held in a vertical position. An approved installing bar or other device shall be used to ensure proper grade and alignment during placing and finishing of the concrete. Finished joints shall not deviate in horizontal alignment more than one-quarter (1/4) inch from a straight line. If preformed joint fillers are assembled in sections, there shall be no off-sets between adjacent units. No plugs of concrete shall be permitted anywhere within the expansion space.

(4) Longitudinal Hinge Joints: Longitudinal hinge joints shall consist of weakened planes made by forming or sawing grooves in the surface of pavement, equal to at least one-third of the depth of the slab.

(a) Formed longitudinal hinge joints shall be made in the same manner as formed transverse

contraction joints (see Section 2.08(H)(1) above).

- (b) Sawed longitudinal hinge joints having a 1/4 inch maximum width shall be made by sawing grooves after the concrete has hardened. In general, the joint shall be sawed before use by any construction traffic or before opening, if construction traffic does not use the pavement.
 - (c) Whenever the width between forms of pavement under construction is greater than thirteen and one-half (13.5) feet, longitudinal joints shall be constructed so as to divide the pavement into strips.
- I. Testing:
- (1) (2) Test Specimens: An independent testing laboratory designated by the Public Works Director shall fabricate and test specimens. The results shall be reported to the Public Works Director.
- J. Surface Tolerance: N/A at no place exceed 1/4 inch. Areas that do not meet the required surface accuracy shall be clearly marked out, and the contractor shall:
- K. Opening to Traffic: The Public Works Director shall decide when the pavement is to be opened to traffic. In general, the pavement shall not be opened to traffic, including construction traffic, but with the exception of sawing equipment, until seven (7) days after the placing of the concrete, or until the compressive strength of job-site cured six (6) inch by twelve (12) inch cylinders (ASTM Specification C31) averages three thousand (3,000) psi, whichever is longer.
- L. Specification: Except as they may be otherwise superseded by these standards and specifications, the specifications for the preparation and construction of Hydraulic Cement concrete pavement shall conform to the requirements of the following sub-sections of the Texas Department of Transportation's Standard Specifications for Construction of Highways, Streets, and Bridges (current edition):

Division III, Surface Courses and Pavement

Item	360	Concrete Pavement
Item	361	Full-Depth Repair of Concrete Pavement
Item	368	Concrete Pavement Terminals

Division IV, Structures

Item	420	Concrete Structures
Item	421	Hydraulic Cement Concrete
Item	440	Reinforcing Steel
Item	458	Waterproofing, Membranes for Structures
Item	688	Pedestrian Detectors and Vehicle Loop Detectors

2.09 Pavement Markings, Street Signs, and Traffic Control Devices:

A. Description: This section regulates the application of pavement markings and the installation of street signs and traffic control devices as reflected on the approved engineering plans, or as subsequently identified by the Public Works Director.

B. Pavement Markings:

(1) Pavement markings shall be applied to the new road surface as shown on the approved engineering plans.

(2) The type, color, and location of pavement markings shall be in conformance with the Texas Manual on Uniform Traffic Control Devices (current edition).

(3) Pavement markings shall be applied in conformance with Division VI, "Lighting and Signage", Item 666, "Reflectorized Pavement Markings," of the Texas Department of Transportation's Standard Specifications for Construction of Highways, Streets, and Bridges (current edition).

(4) Paints shall comply with the requirements for Type II Marking Materials as defined in Item 666, and shall include reflectorized glass traffic beads.

C. Street Signs:

(1) Reflectorized street signs bearing the name of the street and utilizing the existing City of South Padre Island street sign design, or as subsequently identified by the Public Works Director, shall be placed at all street intersections.

(2) The Public Works Director shall approve the location and inspect the installation of all street name signs in all subdivisions.

(3) The size, height, and type of sign shall conform to the City design and to TMUTCD Standards and approved by the Public Works Director.

(4) The City shall not issue any certificates of occupancy for any building on any street until the street name sign has been installed and approved.

(5) Street Names:

(a) A street which is, or is planned as, an extension of an existing street shall bear the same name.

(b) The name of a proposed street that is not in alignment with an existing street shall not duplicate the name of an existing or platted street. Names shall be sufficiently different in sound and in spelling from other existing street names so as to avoid confusion.

(c) All the names of proposed streets shall be submitted to the United States Postal Service for comment, and approved by the Public Works Director.

D. Traffic Control Devices:

(1) The contractor shall bear all expense for the purchase and installation of all traffic regulatory signs and signals required to be placed as required on the approved engineering plans, or as subsequently identified by the Public Works Director.

(2) The location and type of traffic regulatory signs and/or signals required shall be determined by the Public Works Director as part of the engineering plan approval.

(3) The specifications for traffic regulatory signs and signals shall be in accordance with the current edition of the Texas Manual on Uniform Traffic Control Devices (current edition), and the following sub-sections of the Texas Department of Transportation's Standard Specifications for Construction of Highways, Streets, and Bridges (current edition):

Division VI, Lighting and Signing

Item 636	Aluminum Signs
Item 643	Sign Identification Decals
Item 644	Small Roadside Sign Supports and Assemblies
Item 647	Large Roadside Sign Supports and Assemblies
Item 650	Overhead Sign Supports
Item 652	Highway Sign Lighting Fixtures
Item 654	Sign Walkways
Item 656	Foundations for Traffic Control Devices
Item 658	Delineator and Object Marker Assemblies
Item 680	Installation of Highway Traffic Signals
Item 681	Temporary Traffic Signals
Item 682	Vehicle and Pedestrian Signal Heads
Item 684	Traffic Signal Cables
Item 686	Traffic Signal Pole Assemblies (Steel)
Item 688	Pedestrian Detectors and Vehicle Loop Detectors

2.10 Finishing Shoulders, Ditches and Slopes:

A. Description: This section shall regulate the final shaping and dressing of shoulders, ditches, swales, and slopes by hand or machine methods, or both, to the required smoothness and in close conformance to the lines, grades, elevations, and cross-sections shown on the approved engineering plans, or as designated by the Public Works Director.

B. Construction Requirements:

(1) The minimum width of shoulders shall be in conformance with the requirements of Section 2.03(L) of these standards and specifications. The shoulder width shall be measured from the edge of the pavement to the point of intersection between the shoulder slope and the side slope.

(2) Unless otherwise provided, shoulders shall be constructed of earth or other approved material which contains no sod, weeds, sticks, roots, or other perishable matter.

(3) The inside edges shall be built up slightly above the finished surface of the adjoining pavement or stone shoulder and compacted thoroughly with a roller weighing no less than five (5) tons and with the roller wheels slightly overlapping the stone shoulder. Rolling shall continue until there is no break between the pavement and shoulders, and until the required cross-section is obtained.

(4) In those areas where rolling is not practical, compaction shall be obtained with mechanical tamps, vibrators, or other means as may be approved by the Public Works Director.

(5) Ditches, swales, and other earthen drainage ways shall be finished to the lines and grades shown on the approved engineering plans, or as otherwise designated by the Public Works Director.

(6) All cut and fill slopes shall be constructed to the cross-sections shown on the approved engineering plans. Cut and fill slopes shall be finished to the degree ordinarily obtained by a blade grader, scraper, or hand shovel.

(7) Specification: Except as they may be otherwise superseded by these standards and specifications, the specifications for the final shaping and dressing of shoulders, ditches, swales, and slopes shall conform to the requirements of the following sub-sections of the Texas Department of Transportation's Standard Specifications for Construction of Highways, Streets, and Bridges (current edition):

Division I, Earth Work and Landscape

Item 110	Excavation
Item 112	Subgrade Widening
Item 132	Embankment
Item 134	Backfilling Pavement Edges
Item 150	Blading
Item 152	Road Grader Work
Item 154	Scraper Work
Item 156	Bulldozer Work
Item 158	Specialized Excavation Work
Item 160	Top Soil

2.12 Curbs and Gutters:

- A. Description: This section shall regulate the installation of Hydraulic Cement concrete curbs and gutters as required by the approved engineering plans, or as subsequently required by the Public Works Director.
- B. Location: Hydraulic Cement concrete curbs and gutter shall be provided along both sides of all streets.
- C. Dimensions: Curbs shall be five and three-fourths (5 3/4) inch, Ty II Curb (monolithic), Ty II curb or Ty II Curb and Gutter as shown on the plans. Curbs and gutters shall conform to the typical cross-sections as shown on TxDOT Standard CCG-12 in Article 8, "Standard Plans."
- D. Materials: The quality of the material in the design of the concrete mixture for curbs and gutters shall conform to that of rigid pavement as specified in Section 2.08, "Hydraulic Cement Concrete Pavement."
- E. Joints: Joint construction shall be in accordance with Section 2.08, "Hydraulic Cement Concrete Pavement." Joints not covered by these standards and specifications shall be constructed as directed by the Public Works Director. Joints in curbs and gutters shall be sealed for the full width of the section.
- F. Curing: The curing for concrete curb and gutter sections shall conform to that of a rigid pavement as specified in Section 2.08, "Hydraulic Cement Concrete Pavement."
- G. Weather Limitations: The weather limitations effecting concrete curb and gutter sections shall be the same as that of a rigid pavement as specified in Section 2.08, "Hydraulic Cement Concrete Pavement."
- H. Subgrade: The preparation of the subgrade for concrete curb and gutter sections shall conform to that of a rigid pavement as specified in Section 2.08, "Hydraulic Cement Concrete Pavement."
- I. Other Specifications: Except as they may be otherwise superseded by these standards and specifications, the installation of concrete curbs and gutters shall conform to the requirements of the following sub-sections of the Texas Department of Transportation's Standard Specifications for Construction of Highways, Streets, and Bridges (current edition):

Division III, Surface Courses and Pavement

Item 360 Concrete Pavement

Division IV, Structures

Item 420 Concrete Structures

Item 421 Hydraulic Cement Concrete

Item 427 Surface Finishes for Concrete

Item 438 Cleaning and/or Sealing Joints and Cracks (Rigid Pavement and Bridge Decks)

Item 440 Reinforcing Steel

Item 458 Waterproofing, Membranes for Structures

Division V, Miscellaneous Construction

Item 529 Concrete Curb, Gutter, and Combined Curb and Gutter

2.13 Sidewalks:

A. Description: This section shall regulate the installation of Hydraulic Cement concrete sidewalks, as required by the approved engineering plans or as subsequently required by the Public Works Director.

B. Sidewalk Specifications:

- (1) Sidewalks shall be constructed of Hydraulic Cement concrete conforming to the same specification as rigid pavement as required by Section 2.08, "Hydraulic Cement Concrete Pavement."
- (2) Sidewalks shall be constructed in one course, minimum thickness as shown on the plans. The grade of the new sidewalk shall be in conformity with the grade established in the approved engineering plans, and shall have a slope two (2) percent. Sidewalks shall have a longitudinal slope no greater than one (1) inch per foot.
- (3) The subgrade of sidewalks shall be constructed to the required depth below the finished surface in accordance with the approved engineering plans, and shall be compacted to a smooth, firm surface. All soft and spongy places not affording a suitable subgrade shall be removed and replaced with granular backfill and compacted.
- (4) The forms for sidewalks shall be of metal or wood, straight and free of warp, and of sufficient strength to resist springing during the process of depositing concrete against them. The forms shall be the full depth of the sidewalk and shall be securely staked, braced, and held firmly at the required line and grade. All forms shall be thoroughly cleaned and oiled before concrete is placed against them. Bracing and staking of forms shall be such that the forms remain in both horizontal and vertical alignment until their removal.
- (5) Transverse joints shall be made at an interval of five (5) feet and only with a proper joint cutting tool or metal division plates. Expansion joints shall be placed at intervals not to exceed twenty-five feet. Expansion and isolation joints filler (asphalt impregnated type) shall be preformed, resilient, non-extruding, asphalt impregnated cane fiber joint filler conforming to ASTM C175-73. Joint sealer shall be either a hot-poured or cold applied type rubber joint sealer. A polyethylene tape bond breaker shall be used with all cold-applied sealers.
- (6) Omitted
- (7) Omitted
- (8) Finishing: The surface of the sidewalk shall be finished with a wooden float. No plastering of the surface shall be permitted. All outside edges of the sidewalk and all joints shall be edged with a one-quarter inch radius edging tool.
- (9) Curing: The curing for concrete sidewalks shall conform to that of a rigid pavement as specified in Section 2.08, "Hydraulic Cement Concrete Pavement."
- (10) Testing and Surface Tolerance: The testing and surface tolerance for concrete sidewalks shall conform to that of a rigid pavement as specified in Section 2.08, "Hydraulic Cement Concrete Pavement."

(11) All sidewalks must comply with the Texas Accessibility Standards (TAS) regulations pertaining to sidewalks.

C. Other Specifications: Except as they may be otherwise superseded by these standards and specifications, the installation of concrete sidewalks and curb and gutter shall conform to the requirements of the following sub-sections of the Texas Department of Transportation's Standard Specifications for Construction of Highways, Streets, and Bridges (current edition):

Division III, Surface Courses and Pavement

Item 360 Concrete Pavement

Division IV, Structures

Item 420 Concrete Structures
Item 421 Hydraulic Cement Concrete
Item 427 Surface Finishes for Concrete
Item 438 Cleaning and/or Sealing Joints and Cracks (Rigid Pavement and Bridge Decks)
Item 440 Reinforcing Steel
Item 458 Waterproofing, Membranes for Structures

Division V, Miscellaneous Construction

Item 531 Sidewalks

2.14 Driveways, Alleys, Entrances and Approaches:

A. Description: This section shall regulate the installation of driveways, alleys, entrances, and approaches, as reflected on the approved engineering plans, building permit applications, or as directed by the Public Works Director.

B. Residential Driveway Dimensions:

(1) Depths: Residential driveways shall be constructed as shown to meet or exceed the following depths:

(a) Five (5) inches of reinforced Hydraulic concrete cement.

Minimum strength - 3000 psi

#3 reinforcing steel – 18” c-c

Four (4) inches of sand cushion

(b) Or other hard surface construction (i.e. brick pavers) as approved by the Public Works Director.

(c) City Right-of-Way Permit required before construction of each driveway.

(2) Widths:

(a) One and Two Family Residential:

Minimum - Ten (10) feet

Maximum - Thirty (30) feet.

(b) Three Family Residential and Above:

Minimum – Twenty-four (24) feet

Maximum - Twenty-four (24) feet.

(3) The dimensions and geometrics of that portion of a driveway within the street right-of-way shall conform to the standard shown in Article 8, "Standard Plans."

C. Alleys and Nonresidential Driveway Dimensions:

(1) Depths: Cross-section depths of alleys and / or nonresidential driveways and widening lanes are dependent upon the existing road cross-section, the speed limit, and the nature of the land use served by the entrance. The limits of these depths are as follows:

(a) Six (6) inches of reinforced hydraulic cement concrete. Minimum Strength - 3000 psi,
No. 3 reinforcing steel – 12” c-c or as approved by the Public Works Director,

Six (6) inches of sand cushion or

Compacted and Stable Subgrade

(b) Or other hard surface construction (i.e. brick pavers) as approved by the Public Works Director.

(2) Width: Alleys and / or nonresidential driveways shall be constructed to no more than a thirty-six (36) foot width unless otherwise approved by the Public Works Director.

(3) The dimensions and geometrics of that portion of a driveway within the street right-of-way shall conform to the standard shown in Article 8, "Standard Plans."

- D. Relationship to Sidewalks: Where driveways cross the sidewalk, they shall be constructed of concrete, six (6) inches thick, of the same finish and material as specified for the sidewalk, and at the same two (2) percent grade approved for the sidewalk. All sidewalks within driveways must comply with the Texas Accessibility Standards (TAS) regulations pertaining to sidewalks and pedestrian walkways.
- E. General Requirements: For residential and nonresidential driveways, the subgrade, materials, design requirements and other requirements shall conform to the requirements for the applicable rigid pavement of these standards and specifications.
- F. Culverts: Culverts under all driveway entrances and/or approaches shall be constructed and installed whenever necessary to provide adequate drainage in accordance with the approved engineering plans, building permit, or as directed by the Public Works Director. The minimum size culvert shall be a reinforced Hydraulic Cement concrete pipe (RCP), twelve (12) inches in diameter, and.
- G. Drainage: Driveways and Entrance approaches shall not be constructed in a manner which will negatively impact lateral drainage or drainage structures.
- H. Other Specifications: Except as they may be otherwise superseded by these standards and specifications, the installation of driveways, entrances, and approaches shall conform to the requirements of the following sub-sections of the Texas Department of Transportation's Standard Specifications for Construction of Highways, Streets, and Bridges (current edition):

Division V, Miscellaneous Construction

Item 530 Intersections, Driveways, and Turnouts

2.16 Backfill and Compaction:

- A. All Backfill and Compaction shall comply with appropriate Sections/Divisions of the Texas Department of Transportation's Standard Specifications for Construction of Highways, Streets and Bridges (current edition).

2.19 Valley Gutters:

- A. Description: This section shall regulate the installation and use of valley gutters, as reflected upon the approved engineering plans, or subsequently approved by the Public Works Director.
- B. Dimensions and Grades: Valley gutters shall generally follow the pattern indicated by the typical details shown in Article 8, "Standard Plans," with actual plans, dimensions, and grades for specific crossings being shown on the submitted engineering plans.
- C. Materials and Design: Valley gutters shall be constructed of:

(1) Hydraulic Cement concrete (rigid pavement as per Section 2.08 of these specifications) when the adjacent regular street sections are of similar paving material.

(2) Hydraulic Cement concrete (rigid pavement as per Section 2.08 of these specifications) when the adjacent regular street sections are of hot asphaltic concrete.

(3) Full depth hot asphaltic concrete (as per Section 2.07 of these specifications) for a width not less than four (4) feet each side of the gutter thread line when the adjacent regular street sections are paved of hot asphaltic concrete.

- D. Joints: No joint parallel to the thread line of a valley gutter shall be less than four (4) feet from said thread line. The joints lateral to valley gutter sections should be of an approved type which, based upon the Public Works Director approval, have the least potential for allowing surface runoff to infiltrate along the joint into the pavement or subgrade.
- E. Subgrade: Subgrade shall conform generally to the provisions of Section 2.05 of these specifications excepting, however, the subgrade under a valley gutter must be "hand-shaped" in order to control a full and uniform paving thickness in relation to that of the adjacent regular street sections.

5.03 Storm Water Sewer System Specifications:

- A. Description: This section regulates construction, installation, and materials specifications for storm water sewer improvements as shown on the approved engineering plans, or as subsequently approved by the Public Works Director.
- B. Pipe Materials: The type and class of pipe to be used shall be as described herein and shown as such on the submitted engineering plans. The contractor shall provide the Public Works Director with a pipe certification for each job.

(1) Reinforced Concrete Pipe (RCP)(Standard):

(a) Specification: Precast reinforced concrete pipe shall conform to the design shown on the plans and to ASTM C76 or C655 for circular pipe; ASTM C506 for arch pipe; or ASTM C507 for horizontal elliptical pipe.

(b) Joints: Reinforced concrete pipe may be jointed using mortar, cold-applied plastic asphalt sewer joint compound, rubber gaskets, or cold-applied preformed plastic gaskets. For all jointing materials except mortar, the contractor shall furnish the Public Works Director with the Manufacturer's Certificate of Compliance.

(2) Corrugated Polyethylene Pipe (CPP)(Special Use): Specification: High density Corrugated Polyethylene Pipe shall conform to the design shown on plans and to the following:

AASHTO M252: Specification for Corrugated Polyethylene Drainage Tubing, 3- to 10- Inch Diameter

AASHTO M294: Specification for Corrugated Polyethylene Pipe, 12- to 48- Inch Diameter

ASTM D1056: Specification for Flexible Cellular Materials - Sponge or Expanded Rubber

ASTM D1248: Specification for Polyethylene Plastics Molding and Extrusion Materials

ASTM D3350: Specification for Polyethylene Plastics Pipe and Fittings Materials

ASTM D2321: Practice for Underground Installation of Flexible Thermoplastic Sewer Pipe

The product supplied under this specification shall be high density polyethylene corrugated exterior/smooth interior pipe. Four- through 10-inch diameters shall meet all the requirements of AASHTO M252 with the addition that the pipe have a smooth interior liner. Twelve- to 36-inch diameters shall conform to AASHTO M294 Type S. Forty-two and 48-inch diameters shall have minimum pipe stiffness of 20 and 17 psi, respectively, at 5% deflection; and shall meet all other requirements of AASHTO M294.

Material shall meet ASTM D 1248 Type III, Category 4, grade P33, Class C; or ASTM D3350 Cell Classification 324420C.

Minimum conveyance factors shall be based on a Manning “n” value of 0.010 and shall be as shown:

Conveyance Factors			
Nominal Diameter (in.)	Conveyance Factor	Nominal Diameter (in.)	Conveyance Factor
12	46.3	30	532.9
15	83.9	36	866.6
18	136.4	42	1307.2
24	293.9	48	1866.4

Couplings and fittings:

Coupling bands shall cover at least one full corrugation on each section of pipe. When gasketed coupling bands are required, the gasket shall be made of closed-cell synthetic expanded rubber meeting the requirements of ASTM D 1056, Type 2. Gaskets shall be installed on the coupling band by the pipe manufacturer. All coupling bands shall meet or exceed the soil tightness requirement of the AASHTO Standard Specification for Highway Bridges, section 23, paragraph 23.3.1.5.4.(e).

Pipe fittings shall conform to AASHTO M252 or AASHTO M294. Fittings approved by the Public Works Director are also acceptable.

C. Pipe Installation:

(1) Survey Lines and Grades: The setting of survey lines and grades, in conformance with the approved engineering plans, shall be the responsibility of the contractor.

(2) Clearing and Excavating: Except as otherwise specified herein, clearing and excavating shall be conducted in the manner prescribed in subsection (F) of this Article, "Excavation and Backfill for Underground Conduits."

(3) Handling: Pipe materials and fittings shall be handles in a manner to insure installation in a sound and undamaged condition. Pipe materials and fittings should not be dropped or dumped. Slings, lifting bags, hooks, and other devices should be used to protect the pipe, joint elements, and coatings. All pipe materials and fittings should be shipped and stored with provisions to prevent shock contact with adjacent units.

(4) Pipe Laying:

(a) All work shall be in accordance with the Texas Department of Transportation's Standard Specifications for Construction of Highways, Streets and Bridges (current edition).

(b) Equipment, methods, and materials shall be utilized insuring installation to the lines and grades reflected upon the approved engineering plans.

(c) Maintain the following tolerances from true alignment and grade:

Alignment	two (2) inches
Grade	± one-half (1/2) inch

Joint deflection shall not exceed the maximum allowable deflection per pipe joint according to ASTM C425, ASTM C594, and AWWA C600. Only one correction for alignment and/or grade shall be made between adjacent manholes.

(d) Except where pipe sections are being encased in concrete, no pipe is to be supported by blocks.

(e) Accomplish curve alignments with bends, bevels, and upper joints. Joint deflection shall not exceed the maximum allowable deflection per joint according to ASTM C425, ASTM C594, and AWWA C600.

(f) All pipe shall be inspected for soundness and damage due to handling before being lowered into the trench. Any pipe found to be damaged will be removed immediately from the site of the work.

(g) The interior of all pipes, pipe fittings, and joints shall be cleaned prior to installation.

(h) All pipe shall be laid accurately to the required line and grade, and in such a manner as to form a close concentric joint with the adjoining pipe, and to bring the invert of each section to the required grade. Bell holes shall be dug in advance of the pipe being laid.

(i) Pipe laying shall proceed upgrade, beginning at the lower end of the sewer, unless otherwise approved by the Public Works Director. The spigot or tongue end of each pipe shall be installed downstream.

(j) All open ends of pipes and branches shall be sealed with plugs or bulkheads firmly held in place in a manner acceptable to the Public Works Director. At the end of each day's work, the open ends of all pipes shall be satisfactorily protected against entrance of animals, earth, or other materials.

(k) Each length of section shall be properly pulled or shoved "home" with a winch or "come-a-long," against the section previously laid, to make a proper joint. The pipe shall then be securely held in position during the backfill operations. Joints shall not be pulled or cramped more than the design of the joint will permit and so as not to injure the conduit.

(l) Pipe shall only be installed when weather and trench conditions are suitable. The pipe shall be anchored or braced as required to prevent displacement after establishing the final position.

(5) Jointing:

(a) General Requirements:

(i) Joints shall be located to provide for differential movement and changes in the type of pipe embedment, concrete collars, and structures. The pipe shall be supported from the wall of the manhole to the first joint in a normal sewer trench with a concrete cradle structurally continuous with the

base slab or footing.

(ii) All joint and gasket surfaces shall be cleaned and lubricated with a lubricant recommended by the pipe manufacturer.

(iii) Methods and equipment shall be utilized capable of fully homing or making up the joints without damage.

(iv) The joint opening and deflection shall be checked for specification limits.

(v) Each piece of pipe shall be examined prior to installation for soundness and compliance with specifications.

(b) Provisions for Jointing Reinforced Concrete Pipe:

(i) Reinforced concrete pipe may be jointed using cold-applied plastic asphalt sewer joint compound, rubber gaskets, or cold-applied preformed plastic gaskets. For all jointing materials, the contractor shall furnish the Public Works Director with the Manufacturer's Certificate of Compliance.

(ii) Construction methods for preparation and sealing of the joints for reinforced concrete pipe shall be in conformance with Item 464, "Reinforced Concrete Pipe," of the Texas Department of Transportation's Standard Specifications for Construction of Highways, Streets, and Bridges (current edition).

(c) Rubber Gasket Joints: Check gasket position and condition after assembly with a feeler gauge prior to installation of the next section.

(d) Vertical Pipe Deflections: Vertical pipe deflections after installation shall not exceed five (5) percent of the pipe diameter.

(e) Temporary Plugs:

(i) Plugs: Plugs shall be provided and installed as manufactured by the pipe manufacturer. Plugs fabricated by the contractor may only be used with the approval of the Public Works Director. Plugs shall be water-tight against heads up to 20 feet of water. The plugs shall be placed in such a manner as to facilitate their removal when required to connect pipe.

(ii) Location: Plugs shall be installed as specified by the Public Works Director, or as reflected upon the approved engineering plans. Also, the open end of the sewer shall be plugged at the end of the work day to prevent the entry of footage material until work is resumed.

(f) Connection to Existing Pipelines and Structures:

(i) The pipe shall be connected to existing structures and pipelines where indicated on the approved engineering plans, or as designated by the Public Works Director. Pertinent sections of these specifications pertaining to joint locations shall be observed.

(ii) The structure will be prepared by making an opening with at least two (2) inches of clearance around the fitting to be inverted. The concrete structure shall be initially cut with a

concrete saw. The opening between the pipe and the manhole wall shall be filled with an expansion grout in such a manner that a water-tight condition will result.

(iii) Manholes to be built on an existing sewer line shall be constructed in such a manner as will not disrupt service of the existing sewer. The manhole base, walls, and invert shall be completed before the top half of the sewer pipe is cut or broken away. Rough edges of the pipes thus exposed shall be covered with expansive grout, in such a manner as to produce a smooth acceptable finish. Any portion of the existing sewer damaged by the contractor shall be repaired or replaced as directed by the Public Works Director, at the contractor's expense.

(iv) Connections between different pipe materials shall be made using a proprietary transition coupling, unless otherwise specified on the approved engineering plans.

(6) Dewatering: Dewatering sufficient to maintain the water level below the surface of the trench bottom shall be accomplished prior to pipe laying or jointing, if not done prior to excavation and placement of the bedding as called for. The dewatering operation, however accomplished, shall be carried out so that it does not destroy or weaken the strength of the soil under or along the side of the trench. Provisions shall be included to prevent floatation of the pipe should the water control measures prove inadequate. When the dewatering operation is ended, the trench shall be replaced in such a manner so as to not disturb the pipe and its foundation.

(7) Bedding Materials: Each pipe shall be laid in the bedding specified upon the approved plans. Unless otherwise specified by the Public Works Director, the contractor shall use Class "B" bedding as reflected in these standards and specifications.

(a) Definition of Terms for Bedding Explanations:

- Bc = Outside Diameter of the Pipe, in inches.
- H = Backfill Cover Above Top of Pipe, in inches.
- D = Inside Diameter of the Pipe, in inches.
- d = Depth of Bedding Material Below the Pipe, in inches.

The value of "d," depth of bedding material below the bell of the pipe shall be as follows:

<u>"D" inside diameter of pipe</u>	<u>"d" depth of bedding material</u>
27 inches and smaller	3 inches
30 to 60 inches	4 inches
Larger than 60 inches	6 inches

(b) Class "A" Bedding (Concrete Cradle):

(i) Class "A" bedding is that method of bedding in which the conduit is set on "d" inches of concrete in an earth foundation and encased in concrete up to 1/4" of "Bc" to fit the lower part of the conduit's exterior breadth. The remainder of the conduit is to be surrounded to a height of at least twelve (12) inches above its top by densely compacted granular fill material carefully placed by hand to completely fill all spaces under and adjacent to the conduit, unless otherwise specified by the Public Works Director.

(ii) The fill shall be tamped thoroughly on each side and under the conduit, as far as practicable, in layers not to exceed six (6) inches in thickness.

(iii) The concrete used for Class "A" bedding shall be plain concrete with a 28-day compressive strength of 3,000 psi, unless otherwise specified by the Public Works Director.

(c) Class "B" Bedding: Class "B" bedding is that method of bedding in which the conduit is set on "d" inches of sand cushion in an earth foundation, carefully shaped to fit the lower part of the conduit exterior for a width of at least sixty (60) percent of the conduit's breadth. The remainder of the conduit is to be surrounded to a height of at least twelve (12) inches above its top by densely compacted granular backfill material carefully placed by hand to completely fill all spaces under and adjacent to the conduit. The fill to be tamped thoroughly on each side and under the conduit, as far as is practicable, in layers not to exceed six (6) inches in thickness. Bell excavation shall also be provided.

(d) Class "C" Bedding: Class "C" bedding is that method of bedding in which the conduit is set on an earth foundation, carefully shaped to fit the lower part of the conduit exterior for a width of at least fifty (50) percent of the conduit's breadth. The remainder of the conduit is to be surrounded to a height of at least twelve (12) inches above its top by lightly compacted granular backfill material carefully placed around the exterior of the conduit. Bell excavation shall also be provided.

(e) Unstable Subgrade Conditions: If unstable subgrade conditions are encountered on the site, and it is determined by the Public Works Director that the bedding specified upon the approved engineering plans will not provide suitable support for the pipe, additional excavation to the limits determined by the Public Works Director will be required. This additional excavation will be backfilled with crushed stone material, approved by the Public Works Director, to provide the necessary support.

(f) Sewer Line Connections: Connections to trunks, mains, and side sewers shall be left uncovered until after an acceptance inspection has been made by the Public Works Director. After approval of the connection, the bare pipe shall be covered with compacted granular backfill material to a minimum depth of twelve (12) inches above the crown of the pipe. The trench shall then be fully backfilled as required.

(8) Cross-Connections Prohibited: No storm water drain, roof drain, or drain tile shall be connected into a sanitary sewer line.

D. Manholes:

(1) Generally: Manholes shall be installed where shown on the approved engineering plans, or where subsequently designated by the Public Works Director. They must be constructed according to these standards and specifications. The tops of all manhole castings shall be placed flush with the proposed elevation reflected upon the approved engineering plans, unless otherwise directed by the Public Works Director.

(2) Materials Specification:

(a) Pre-cast or Cast-in-Place Reinforced Concrete Manholes: all pre-cast or cast-in-place concrete manholes shall be constructed in conformance with ASTM C478. Steps shall be cast-in-place in accordance with the requirements of these standards and specifications. All concrete, reinforcing, and wall thickness shall be in accordance with ASTM C478. All manhole joints shall be watertight and constructed in accordance with ASTM C443. The bottom of the structures shall be of either pre-cast,

poured-in-place, or monolithic bottom stack, with 3,000 psi, concrete to conform to the approved engineering plans, and shall be at least eight (8) inches thick and reinforced as required by these standards and specifications.

(b) Polyethylene Manholes: The use of polyethylene manholes, conforming to ASTM D1248, and comparable to those distributed by Advanced Drainage Systems, Inc., may be substituted under special conditions with the approval of the Public Works Director.

(c) Manhole Steps: Manhole steps, when required, shall be furnished and installed as per these standards. The steps shall be located as follows:

(i) The first step shall be positioned no greater than thirty-six (36) inches below the finished surface grade.

(ii) The last step shall be so situated that it is no greater than twenty-four (24) inches above the spring line or invert or the outfall pipe, whichever is less.

(iii) The maximum acceptable interval between steps shall be sixteen (16) inches.

(iv) All steps shall be of either cast iron or approved non-corrosive fiberglass materials. Cast iron steps shall be tumbled or sandblasted and all burrs and sharp edges removed. All materials used in the manufacture of steps shall conform to the latest edition of ASTM specifications.

(d) Material for Jointing Manholes: Material for jointing manholes shall be one (1) part Hydraulic Cement to not less than one (1) part nor more than two (2) parts Mason's sand mixed with the least amount of clean water necessary to provide a workable mixture.

(e) Pre-Cast Manhole Components: Pre-cast manholes shall conform to ASTM C478, latest edition. Cones and sections shall be substantially free from fractures, large or deep cracks, and surface roughness. Slabs shall be sound and free from gravel pockets, all pre-cast manhole components shall be manufactured by an experienced and reputable manufacturer whose pre-cast manhole components have been used commercially for at least three (3) years.

(f) Monolithic Concrete Manholes: Monolithic concrete manholes shall conform to the approved engineering plans unless otherwise specified by the Public Works Director. Walls and dimensions shall be of approved thickness and the maximum step spacing shall be sixteen (16) inches.

(g) Cast Iron Frames, Covers, and Steps: Gray cast iron frames, covers, and steps shall conform to the requirements of ASTM A48 for Gray Cast Iron, latest edition. The dimensions, weights, and finish preparation shall conform to the appropriate construction standards, unless otherwise designated by the Public Works Director.

(h) Ductile Cast Iron Frames, Covers, and Grates: Ductile cast iron frames, covers, and grates shall conform to the requirements of ASTM A536. Dimensions, weights, and finish preparations shall conform to the appropriate construction standards, unless otherwise designated by the Public Works Director.

(3) Construction Details:

(a) Dewatering: Dewatering of the site shall conform to the same requirements for sewer trench dewatering. Subgrade preparation is an adequate foundation for all manhole structures and shall be obtained by removal and replacement of all unsuitable material with six (6) inch minimum crushed stone, or such other means as designated by the Public Works Director.

(b) Bedding: Pre-cast base sections shall be placed on a well-graded granular bedding course conforming to the requirements for sewer bedding, but not less than four (4) inches in thickness and extending to the limits of the excavation. The bedding course shall be firmly tamped and made smooth and level to assure uniform contact and support of the pre-cast element.

(c) Cast-in-Place Bases: Unless otherwise specified, the cast-in-place bases shall be at least eight (8) inches in thickness and shall extend at least six (6) inches radially outside of the outside dimensions of the manhole section. The cast-in-place base shall be made of 3,000 psi concrete, 28-day compression test, and shall be reinforced as shown on the approved engineering plans or as otherwise specified by the Public Works Director.

(d) Lift Holes and Joints: All lift holes and joints between pre-cast elements in manholes shall be thoroughly wetted and then be completely filled with non-shrinking concrete grout, smoothed and painted both inside and out, to insure water tightness. All joints between pre-cast elements in manholes shall be made with an approved bitumastic material or an approved rubber gasket in accordance with ASTM C443, latest edition. Pre-cast sections shall be placed and aligned to provide vertical sides and vertical alignment of the ladder rungs. The completed manhole shall be rigid, true to dimensions, and be watertight.

(e) Placing of Castings:

(i) Castings Placed on Concrete Surfaces: Castings placed on concrete surfaces shall be set in full grout beds. The grout shall be mixed in a proportion of one (1) part Hydraulic Cement to three (3) parts Mason's sand, by volume, based upon dry materials. Castings shall be set accurately to the finished elevation so that no subsequent adjustment will be necessary or unless otherwise specified by the Public Works Director.

(ii) Streets at Grade: Where work is in paved streets or areas which have been brought to grade, not more than fifteen (15) inches shall be provided between the top of the cone or slab and the underside of the manhole casting for adjustment of the casting to street grade.

(iii) Unpaved Streets or Alleys: Where work is in an unimproved street or alley, not less than twelve (12) inches of adjusting rings shall be provided between the top of the cone or slab and the underside of the manhole casting for adjustment of the casting to finished grade. The top of the manhole casting shall be flush with the finished grade unless otherwise specified by the Public Works Director.

(iv) Manholes Within Vegetated Areas: Where work is in vegetated areas, the top of the manhole casting shall be flush with the finished grade unless otherwise specified by the Public Works Director.

(v) Reducing Cone: Where the last manhole section is a reducing cone and is set to final grade as required by the Public Works Director; then if as part of the continuous work, it becomes

necessary to lower this casting, and it entails going below the cone, compensation to the contractor may be allowed for said adjustment and changing of the manhole stacks.

(vi) Adjusting Rings: When adjusting rings are used to set the castings to grade, they shall be pointed up and made watertight.

(f) Channels and Inverts: Channels and inverts shall be made to conform accurately to the sewer characteristics and grades, and shall be brought together smoothly with well-rounded junctions, satisfactory to the Public Works Director, and in accordance with the approved engineering plans.

(g) Pipe Connections: Special care shall be taken to see that the openings through which pipes enter the structure have all pipe ends sawed and smoothed completely. Pipes are to be firmly full of jointing material to ensure watertightness. The pipes shall not protrude further than three (3) inches into the inside face of the manhole, measured along the horizontal center of the pipe. Where polyethylene manholes are used, pipe connections shall be in accordance with the manufacturers specifications, or as specified by the Public Works Director. In the case of a smooth sidewall pipe, rubber water stops, "O" ring gaskets, or poured-in-place pipe sleeves shall be used for watertightness between the pipe and manhole, they shall be core drilled or star drilled in a circle of required diameter then knocked out. In no instance shall new holes be sledge-hammered out.

E. Catch Basins, Inlets, and Special Structures:

(1) Generally: This work shall consist of catch basins, inlets and special structures, together with necessary frames, grates, or lids all constructed in conformance with the approved engineering plans or as directed by the Public Works Director.

(2) Materials: All materials shall conform to the materials requirements for manholes in these specifications.

(3) Construction Methods:

(a) Concrete: Poured or pre-cast concrete structures shall be constructed in conformance with the applicable provisions of the section on manholes.

(b) Pre-cast Reinforced Concrete Sections: Pre-cast reinforced concrete sections shall be laid in grout composed of one (1) part Hydraulic Cement to three (3) parts Mason's sand, by volume, based on dry materials, or an approved bitumastic material.

(c) Placing of Castings: Castings placed on concrete or pre-cast concrete surfaces shall be set in full grout beds. The mortar shall be mixed in proportions of one (1) part Hydraulic Cement to three (3) parts Mason's sand, based on dry materials. Castings shall conform to construction standards and shall be set accurately to the finished elevation so that no subsequent adjustment will be necessary.

(d) Cleaning: All newly constructed catch basins, inlets, and special structures shall be cleaned of an accumulation of silt, debris, or foreign matter of any kind, and shall be free from such accumulations at the time of final inspection.

F. Excavation and Backfill for Underground Conduits:

(1) Generally: For the purpose of this section, underground conduits shall be considered sewer

pipe, or any other pipe conduit indicated on the plans. Wherever the term "pipe" or "pipe line" is used, it shall mean underground conduit. Excavation and backfill shall include all excavation, backfilling, surface removal, disposal of surplus material, regrading of all disturbed surfaces, and all other work incidental to the construction of trenches, including any additional excavation which may be required for manholes, catch basins, inlets or other structures forming a part of the pipe line.

(2) Construction Details:

(a) Surface Removal: Along the proposed pipe line, as indicated on the approved engineering plans, the contractor shall remove the surface materials only to such widths as will permit a trench to be excavated and which will afford sufficient room for proper efficiency and proper construction. Where sidewalks, driveways, pavements, and curb and gutter are encountered, care shall be taken to protect such against fracture or disturbance beyond reasonable working limits. All pavements shall be cut with an abrasive saw; and concrete streets, driveways, walks, alleys, etc., cut to the nearest joint, or as required by the Public Works Director.

(b) Width of Excavation: The width of trenches in earth for pipe sewers, basin connections, house connections, and other structures shall be such as to provide a clearance of not less than six (6) inches or more than fifteen (15) inches on each side of the structure. Sidewalls of pipe trenches shall be vertical from the bottom of the trench to a point not less than twelve (12) inches above the top of the pipe. Above that point, sidewalls may be battered to safe slopes. Trench bracing shall be employed, if necessary, to maintain these maximum widths of trench. The bottom of the trench shall conform to the details shown on the approved engineering plans.

(c) Length of Excavation or Working Zone: In general, the contractor shall confine his raw excavation and working zone to a two (2) block area, but in no case farther than can be backfilled in the same day. Areas that have been excavated and pipes placed which are back from this raw excavation or working zone shall undergo temporary and/or permanent restoration, as spelled out in these standards and specifications.

(d) Excavation Below Grade: In cases where the excavation is carried beyond or below the lines and grades reflected on the approved engineering plans, the contractor shall, at his own expense, refill any such excavated space with suitable granular base material, as required by the Public Works Director.

(e) Subsurface Exploration: All available information and/or written reports on subsurface exploration in the vicinity of the proposed pipe line construction will be made available by the City for examination by the contractor upon request. However, it is expressly understood and agreed that the City shall in no way be held responsible for the interpretation of this information, its accuracy, or its thoroughness. The contractor may make such subsurface explorations as they believe necessary to verify and supplement the information received from the City.

(f) Short Tunnels or Jacking: In some instances, trees, fire hydrants, sidewalks, and other obstructions may be encountered, the proximity of which may be a hindrance to open cut excavation. In such case, as designated by the Public Works Director, the contractor shall excavate by means of short tunnels or jacking of pipe in order to protect such obstructions against damage.

(g) Piling Excavated Material: All excavated material shall be piled in a manner that will not endanger the work and that will avoid obstructing sidewalks and driveways. Fire hydrants under pressure, valve pit covers, valve boxes, curb stop boxes, or other utility controls shall be left unobstructed

and accessible until the work is completed. Gutters shall be kept clear or other satisfactory provisions made for street drainage. Natural watercourses shall not be obstructed for a period not to exceed the normal working day.

(h) Trenches to be Dry: All water shall be removed from the trench to a depth below the outside of the pipe bell prior to the laying of the pipe, or to a depth to prevent rolling of the base material, whichever is greater.

(i) Base Stabilization: After the trench is excavated to grade, the Public Works Director, or his designee, shall examine the base and determine whether or not it is satisfactory for pipe laying. If the base is not satisfactory, it shall be removed and replaced with crushed stone as ordered by the Public Works Director. The crushed stone shall have a minimum size of one (1) inch and a maximum size of two and one-half (2.5) inches, and extend a minimum depth of six (6) inches below the barrel of the pipe. Should the base still not be suitable for adequate support of the pipe (e.g., a boiling or quicksand situation, muck, etc.), the contractor shall bring alternate methods of suitable construction techniques to the Public Works Director for approval.

(3) Safety:

(a) Barricades, Guards, and Safety Provisions: The contractor shall, before closing roads or pedestrian accessways, furnish and erect standard barricades and signs to protect the public. These barricades and signs shall be placed and adequately maintained in accordance with the Texas Manual on Uniform Traffic Control Devices (current edition), or the appropriate governing agency's requirements.

(b) Existing Underground Structures: Existing storm sewers, sanitary sewers, water mains, electric conduits, telephone conduits, cable television conduits, and other underground structures shall be reflected on the submitted engineering plans according to the best available information. The exact location and protection of these facilities and structures, their support and maintenance in operation during construction, is the express responsibility of the contractor (in cooperation with the proper authorities of the respective utility involved).

(c) Structure Protection: Temporary support and adequate protection and maintenance of all underground and surface structures, drains, sewers, and other obstructions encountered in the progress of the work shall be furnished by the contractor at his expense, and under the direction of the Public Works Director. The structures, which may have been disturbed, shall be restored by the contractor upon the completion of the work, or as required by the Public Works Director.

(d) Protection of Property and Surface Structures: Trees, shrubbery, fences, poles, and all other property and surface structures shall be protected during construction operations, unless their removal for purposes of construction is authorized by the Public Works Director. Any fences, poles, or other man-made surface improvements which are moved or disturbed by the contractor, and are outside of the construction right-of-way or permanent easement, shall be restored to their original condition at the contractor's expense. Any trees, shrubbery, or other vegetation which are approved for removal by the Public Works Director in order to facilitate construction operations, shall be removed completely, including stumps and roots, by the contractor. Responsibility for any damages or claims for damage caused by the construction operations to trees, shrubbery, or other landscape improvements which were not authorized for removal, shall be assumed by the contractor. Settlement of any damage claims for such damage shall be made by the contractor as soon as possible and in a manner satisfactory to the damaged party and/or the Public Works Director.

(e) Caution in Excavation: The contractor shall proceed with caution in the excavation and preparation of the trench so that the exact location of underground structures, both known and unknown, may be determined. The contractor shall be held responsible for the repair of such structures when broken or otherwise damaged by the construction operations.

(4) Deviations Occasioned by Other Structures or Utilities: Whenever obstructions are encountered during the progress of the work and interfere to such an extent that an alteration in the plan is required, the Public Works Director shall have the authority to change the plans and order a deviation from the line and grade, or arrange with the owners of the structures for the removal, relocation, or reconstruction of the obstructions. Where gas, water, telephone, electrical, cable television, or other existing utility is an impediment to the vertical or horizontal alignment of the proposed pipe line, the Public Works Director shall have the authority to order a change in grade or alignment, or shall direct the contractor to arrange with the respective utility for their removal.

(5) Interruption to Utilities: The contractor shall take all reasonable precautions against damage to existing utilities. However, in the event of a break in an existing utility line, the contractor shall immediately notify the responsible official from the organization operating the utility interrupted. The contractor shall lend all possible assistance in restoring service, and shall assume all costs, charges, or claims connected with the interruption and repair of such service.

(6) Interference With and Protection of Streets: The contractor shall not close or obstruct any portion of a street without first notifying, in writing, the Public Works Director. The contractor shall give the Public Works Director a minimum of five (5) working days' notice in advance of starting any work on or affecting a road, property, or facilities. Streets, roads, private ways, and sidewalks shall be maintained passable by the contractor, at his expense, and the contractor shall assume full responsibility for the adequacy and safety of the provisions made therefore.

(7) Construction in Easements (Permanent and Temporary): In easements across private property, the contractor shall confine all operations within the easement area and shall be responsible and liable for all damage outside the easement area. Precautions shall be taken by adequate sheeting or other approved method to prevent any cave-in or subsidence beyond the easement limits, damage to improvements, or to provide reasonable access and working area for efficient operation by the contractor.

(8) Backfill:

(a) Backfill Material: The backfill material shall comply with the requirements of Item 400, "Excavation and Backfill for Structures," of the Texas Department of Transportation's Standards and Specifications For Construction of Highway's, Streets, and Bridges (current edition). At the contractor's request, the excavated material may be used for backfilling the trench, provided it meets the Texas Department of Transportation requirements, and is approved by the Public Works Director as being suitable material.

(b) Compacting Backfill:

(i) Approved Methods of Compaction: All backfill material shall be compacted to the density specified in the Texas Department of Transportation's Standards and Specifications For Construction of Highway's, Streets, and Bridges (current edition), which shall be obtained by either water jetting or mechanical tamping the backfill material in six (6) inch lifts. The contractor shall show proof of obtaining the required compaction prior to the placement of any permanent surfacing.

(ii) Right-of-Way Backfill: All backfill material within the right-of-way of all streets shall be compacted in one of the following manners: The backfill material shall be deposited in six (6) inch layers and shall be thoroughly tamped or compressed, either by an approved air tamp, vibrator, or in a large excavated area, by a ten (10) ton roller. The backfill material, if suitable, shall be deposited in the trench and compacted by jetting with water. The contractor shall provide and install weep holes in all structures, as required by the Public Works Director.

(iii) Jet Holes: The holes through which water is injected into the backfill shall be centered over the trench backfill and at longitudinal intervals of not more than six (6) feet. Additional holes shall be provided if deemed necessary by the Public Works Director to secure adequate settlement. All holes shall be jetted and shall be carried to a point one (1) foot above the top of the pipe. Drilling the holes by means of augers or other mechanical means will not be permitted. Care shall be taken in jetting so to prevent direct contact with, or disturbance of, the pipe.

(iv) Water Jetting: The water shall be injected at a pressure and a rate just sufficient to sink holes at a moderate rate. After a hole has been jetted to the required depth, the water shall continue to be injected until it begins to overflow the surface. The contractor shall bore test holes at such locations as the Public Works Director may designate in order to determine the effectiveness of the water jetting. An approved solid auger shall be used for boring test holes. As soon as the jetting has been completed, all holes shall be filled with soil and compacted. Surface depressions resulting from backfill subsidence caused by the jetting shall be filled and recompactd by tamping or rolling to the satisfaction of the Public Works Director.

(v) Dust Control: The contractor shall maintain filled surfaces which are subject to vehicular traffic in a continual dust-free condition by the use of approved temporary treatments until final paving or other final treatment of the surface is accomplished.

(vi) Removal of Topsoil: The contractor shall remove all topsoil prior to the excavation for piping. The topsoil shall be removed to a depth of twelve (12) inches below grade. The topsoil shall be stored on the project site for use in final grading and restoration.

(vii) Rip Rap: The contractor shall furnish and place revetment riprap in the areas reflected on the approved engineering plans, and in accordance with the specifications outlined below:

Material: The material shall be of broken rock or rock excavation of a gradation such that: No individual piece weighs more than one hundred twenty (120) pounds. Ninety (90) to one hundred (100) percent of the material passes a 12-inch sieve. Twenty (20) to sixty (60) percent of the material passes a 6-inch sieve. Not more than ten (10) percent of the material passes a 1-inch sieve. Reasonable care shall be taken in loading to obtain a similar gradation for consecutive loads.

Placing Riprap: The revetment riprap may be placed by dumping and shall be graded or placed to the required thickness at the locations shown on the plans. The thickness of the riprap shall be as measured perpendicular to the slope. The slope or area where the riprap is to be placed shall be cut back to the required depth of the riprap so that the final cross-section is smooth and in alignment with the adjacent earthen slopes.

(9) Restoration:

(a) Generally: The restoration of surfaces shall include the construction of repaired surfaces as indicated on the approved engineering plans. The type of surface restoration required shall be shown on the submitted engineering plans or described in the project specifications.

(b) Construction Details:

(i) Temporary Surface Over Trench: Whenever conduits are constructed under traveled roadways, driveways, sidewalks, or otherwise improved surfaces, a temporary surfacing shall be placed over the top of the trench during seasonal periods when final surface materials may not be available. The type of temporary surface shall be approved by the Public Works Director. The temporary surface shall be maintained at the contractor's expense until final restoration of the improved surface is completed as specified.

(ii) Removal of Pavement, Sidewalk, Driveway and Curb: Whenever the pipe is located along or across an improved surface, the width of the trench shall be held as nearly as possible to the excavation zone (O.D. pipe + 30 inches). Where brick or concrete pavement, sidewalk, driveway, or curbing is cut, the width of the cut shall be to the nearest joint. Exposed surfaces of Hydraulic Cement or asphalt over Hydraulic Cement shall be cut with a pavement saw before breaking.

(iii) Replacement of Permanent Type Pavement, Sidewalks, Driveways, Curbs, Gutters, and Structures: The contractor shall restore (unless as otherwise specified by the Public Works Director) all permanent type pavements, sidewalks, driveways, curbs, gutters, fences, poles, and other property and surface structures removed or disturbed during, or as a result of, construction operations to a condition which is equal or better in appearance and quality to the condition that existed before the work began. The surface of all improvements shall be constructed of the same material, unless otherwise specified by the Public Works Director, and match in appearance the surface of the improvements which were removed. Repairs and improvements shall be performed in accordance with Article 2 of these specifications and as noted in Article 8 - Standard Plans.

(iv) Seeding and Sodding: At locations indicated on the approved engineering plans, or where designated by the Public Works Director, the contractor shall prepare seed beds, furnish and spread fertilizers, and furnish and plant the seed as specified herein on the disturbed areas.

(v) Disposal of Surplus Excavated Material: Surplus excavated material not needed for backfill shall be promptly removed from the site by the contractor. Unless otherwise specified by the Public Works Director, all materials and debris removed shall become the property of the contractor.

(vi) Clean-Up: All surplus materials, all tools, and all temporary structures shall be removed from the site by the contractor. All dirt, trees, scrub brush, rubbish, etc., shall be hauled from the project site and suitably disposed of. The construction site should be left clean and acceptable to the Public Works Director at the earliest possible date. Before acceptance of the underground conduit construction, all pipes, manholes, catch basins, inlets, and other appurtenances shall be cleaned of all debris and foreign material. After all backfill has been completed, the ground surface shall be shaped to conform to the contour of adjacent surfaces, unless otherwise specified by the Public Works Director. General clean-up of the entire construction area shall otherwise conform to the applicable requirements specified.

- G. Other Specifications: Except as they may be otherwise superseded by these standards and specifications, the construction, installation, and materials specifications for storm water sewer improvements shall conform to the requirements of the Texas Department of Transportation's Standard Specifications for Construction of Highways, Streets, and Bridges (current edition).

BARRICADES AND CHANNELIZING DEVICES

6.01 Functions:

The functions of barricades and channelizing devices are to warn and alert drivers of hazards created by construction or maintenance activities in or near the traveled way and to guide and direct drivers and/or pedestrians safely past the hazards. In fulfilling these two functions, barricades and channelizing devices are often required to satisfy two opposing requirements. For example, a channelization installation should be constructed to provide protection for men working in the roadway. At the same time, the channelization devices should provide a smooth and gradual transition which reduces the width of the traveled way. In this case, the channelization devices should not inflict any severe damage to a vehicle that inadvertently strikes them, but in doing so runs counter to the goal of providing protection for men working in the roadway. The overall objective should be the development of a traffic plan which uses a variety of traffic control measures in whatever combination necessary to assure smooth, safe vehicular and/or pedestrian movement past the work area, while at the same time, providing maximum safety for the workmen and equipment on the job.

6.02 Safety Plan Required:

Barricades and channelizing devices are elements in a total system of traffic control devices for use in right-of-way construction and maintenance operations. To this end, a safety plan shall be included as an element of the engineering plans submitted for the review and approval of the Public Works Director. The safety plan will designate the various locations where the need for barricades and channelizing devices are anticipated, the type and combination of traffic control devices proposed for use, and the sub-system of warning devices that will precede the traffic control devices, including size, number, and placement. The safety plan will be modified as needed to accommodate safe passage of traffic.

6.03 Barricade Design and Usage:

Provide traffic control devices that conform to details shown on the plans, the Texas Manual on Uniform Traffic Control Devices (current edition), the Compliant Work Zone Traffic Control Device List as maintained by the Traffic Operations Division of TxDOT, and TxDOT Standard Specifications for Construction and Maintenance of Highways, Streets, and Bridges (current edition):

Division V

Item 502 Barricades, Signs, and Traffic Handling

PS-01 Stamped Thermoplastic Pavement Marking

1. Description

Furnish and place Traffic Patterns XD Crosswalk pavement makings or approved equal.

2. Materials

Furnish all materials sunless otherwise shown on plans. Furnish only new materials. Furnish and fabricate materials that comply with the following details shown on the plans:

1. The system manufacturer must be ISO 991:1:2015 certified for design development and manufacturing of performed thermoplastic, and provide proof of current certification.
2. Performed Thermoplastic Material must be composed of an ester modified rosin impervious to degradation by motor fuels and lubrication in conjunction with aggregates, pigments, binders, and anti-skid/anti-slip elements. Pigments and anti-skid/anti-slip elements must be uniformly distributed throughout the material. The material conforms to AASHTO designation M249, with the exception of the relevant differences due to the material being supplied in a performed state, being non-reflective, and potentially being of a color different from white or yellow.
3. Pigments
 - a. White: the material shall be manufactured with sufficient titanium dioxide pigment to meet FHWA Docket No. FHWA-99-6190 Table 5 and Table 6 as revised and corrected.
 - b. Other colors: the pigment system must not contain heavy metals nor any carcinogen, as defined in 29 CFR 1910. 1200 in amounts exceeding permissible limits as specified in relevant Federal Regulations.
4. Skid Resistant: the surface of the material shall contain factory applied anti-skid/anti-slip elements with a minimum hardness of 6 (Mohs Scale). Upon application the material shall provide a minimum skid resistance value of 60 BPN when tested according to ASTM E 303.
5. Slip Resistance: the surface of the material shall contain factory supplied anti-skid/anti-slip elements with a minimum hardness of 6 (Mohs Scale). Upon application the material shall provide a minimum static friction of coefficient of 0.6 when tested according to ASTM C 1028 (wet and dry), and a minimum static coefficient of friction of 0.6 when tested according to ASTM D 2047.
6. Thickness: the material must be supplied at a minimum thickness of 150 mil (3.8mm).
7. Environmental Resistance: the material must be resistant to deterioration due to exposure to sunlight, water, salt, or adverse weather conditions and impervious to oil and gasoline.
8. Storage Life: the material may be stored for 12 months, if stored indoors and protected from the elements.
9. Stamping Templates: a wire rope template is required in the execution of the System. The template is used for imprinting the defined pattern once the performed thermoplastic has been applied. The wire rope diameter for the imprinting template used for the specified pattern is 3/8 in. (9.5mm). The stamping templates are distributed by the System manufacturer.
10. Heating equipment: the system manufacturer shall distribute reciprocating infrared heating equipment designed specifically to elevate the temperature of the performed thermoplastic material and asphalt pavement without adversely affecting it. The primary heating unit must employ a bank of propane-fired infrared heaters, mounted on a track

device that allows the heater bank to reciprocate back and forth over a designated area, thereby allowing the operator to monitor the temperature of the performed thermoplastic at all times during the pavement process.

11. Sealer: a two-part epoxy sealer specified and distributed by the System manufacturer must be applied to the substrate prior to material application to ensure proper adhesion, and to provide reinforcement for larger volumes of material.
12. Specialized sealer dispensing gun: used to dispense the required two-part epoxy sealer onto the substrate. The sealer dispensing gun are distributed by the system manufacturer.
13. Vibratory plate compactor (700-900 lb.): shall be used for pressing the 3/8" (9.5mm) wire rope stamping templates into the thermoplastic to create the specified pattern in both the thermoplastic and asphalt substrate. The System manufacture does not apply vibratory plate compactors.

3. Construction

The system is applied to asphalt pavement using proprietary reciprocating infrared heating equipment. The material must be able to apply at ambient road temperatures down to 45°F (7°C) without any preheating of the pavement to a specific temperature. A two-part epoxy sealer specified by the manufacturer must be applied to the substrate prior to performed thermoplastic application. Immediately following sealer application the panels of the aggregate reinforced performed thermoplastic are positioned properly on the asphalt substrate with the aggregate side facing up. The performed thermoplastic is then heated to the required melting temperature. Additional aggregate may be applied to the performed thermoplastic surface as needed following the melting process. As the material is cooling, it is imprinting with a stamping template made from 3/8 in. (9.5 mm) flexible wire rope in the required design using a vibratory plate compactor. The performed thermoplastic material is then allowed to cool thoroughly before being opened to vehicle or pedestrian traffic. (Consult the manufacturer's published application procedures for complete information).

4. MEASUREMENT

This item will be measured by square foot of stamped thermoplastic making.

5. PAYMENT

The work performed, ad materials furnished in accordance with this item and measured as provided under "Measurement" will be paid for at the unit price bid for "Stamped Thermoplastic Making" of the type and color specified and the shape, width, and size specified as applicable, at the time of project acceptance. This price is full compensation for materials, application of stamped thermoplastic marking, equipment, labor, tools, and incidentals.

PS-02 COMPOSITE MANHOLE RING AND COVER

1. GENERAL:

All composite moldings shall consist of a thermosetting resin matrix blended and/or combined with reinforcing fiber rovings, short fiber filaments, or equivalent nonmetallic reinforcing structure(s). The thermosetting resin matrix shall be a polyester, vinylester, or a blend of these. The moldings shall be true to pattern in form and dimension and free from cracks, pores, knit-lines, or other defects in locations affecting their strength and value for the service intended.

Before the moldings are removed from the molding operation, they shall be thoroughly deflashed and cleaned at the parting lines, holes, notches and all exposed edges.

Composite frames must have a wall thickness of at least 0.75 inches in sections exposed to traffic and potential traffic wheel impact.

If using a lock, bolt, or latch, these must be independent of the method used to open the cover to ensure the cover can be opened in the event of lock failure.

2. MOLDING PROCESS:

Covers and frames shall be compression molded under high pressures (>0.5 tons/sq inch of x-y surface area) and high temperatures (>200 degrees F).

Metal reinforcements or metal hinges molded within the composite shall not be permitted. Small non-stress bearing pieces of metal may be encapsulated.

Composite covers and frames shall be molded in the USA.

3. TESTING AND PERFORMANCE REQUIREMENTS

Testing shall be performed in accordance with the following inspection criteria unless otherwise specified in the contract or purchase order. The manufacturer/supplier shall be responsible for carrying out all of the required tests and inspections. All testing shall be conducted in the United States. The manufacturer/supplier shall maintain complete records of all such tests and inspections. All testing shall be paid for by the manufacturer/supplier.

Frame and Covers shall be test "Proof Load" in accordance with AASHTO M306.

Heavy Duty: A load of 40,000lbs shall be concentrated on a 9"x 9" block with rubber or fiber backing pad for one minute. During the load testing process, visible cracks or delamination will be cause for rejection (popping noises during this test are normal for composites and do not indicate failure). When load is removed, Permanent Set (Deflection) of more than 1/8"(.125") measured at center of load area will be cause for rejection. All testing shall be conducted on a NIST calibrated and Certified load test machine.

Ultraviolet resistance: ASTM G 154 Cycle I for 1000hrs. Specimens shall be tested for ultimate flexural strength (ASTM D790), retaining at least 75% of control values for load and deflection at failure.

Coefficient of Friction: Shall be greater than 0.6 when tested in accordance to ASTM C 1028.

Notched Izod Impact: Composite raw material impact results shall be greater than 5 ft.-lbs/inch when tested in accordance to ASTM D256.

Components for locking systems below the cover exposed to the sewer environment shall be made of noncorrosive materials such as nonmagnetic, 316 stainless steel or a polymer.

Covers shall be the types and shall be imprinted as shown on the plans or standard details.

4. MARKINGS:

Covers and Frames shall have the following molded into the substrate of the cover:

- Name (or Abbreviation) Molder
- Country of Origin
- Molding Date
- Indication that Material is Non-metallic

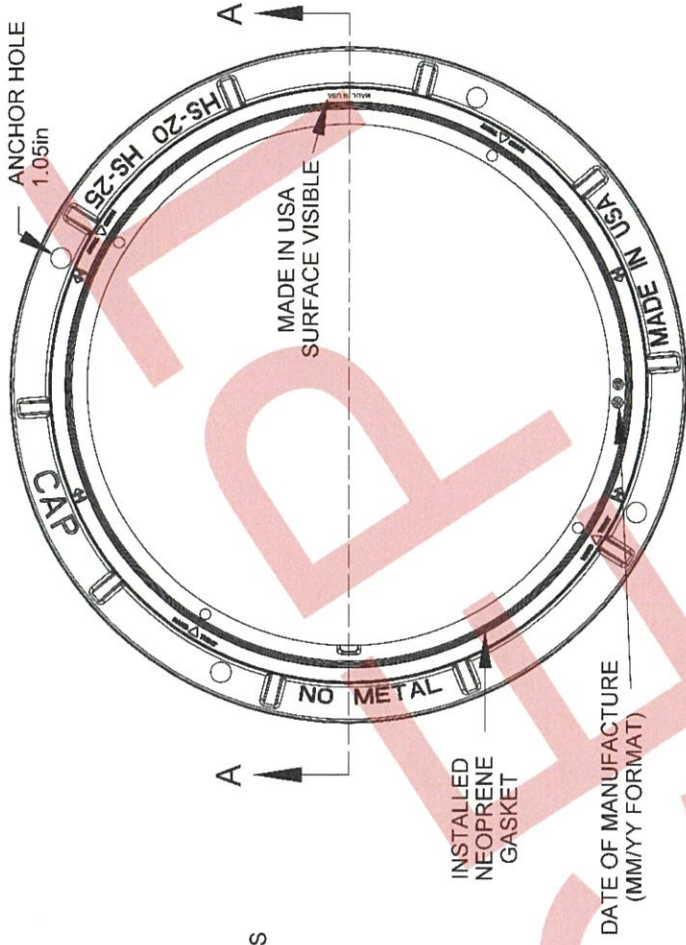
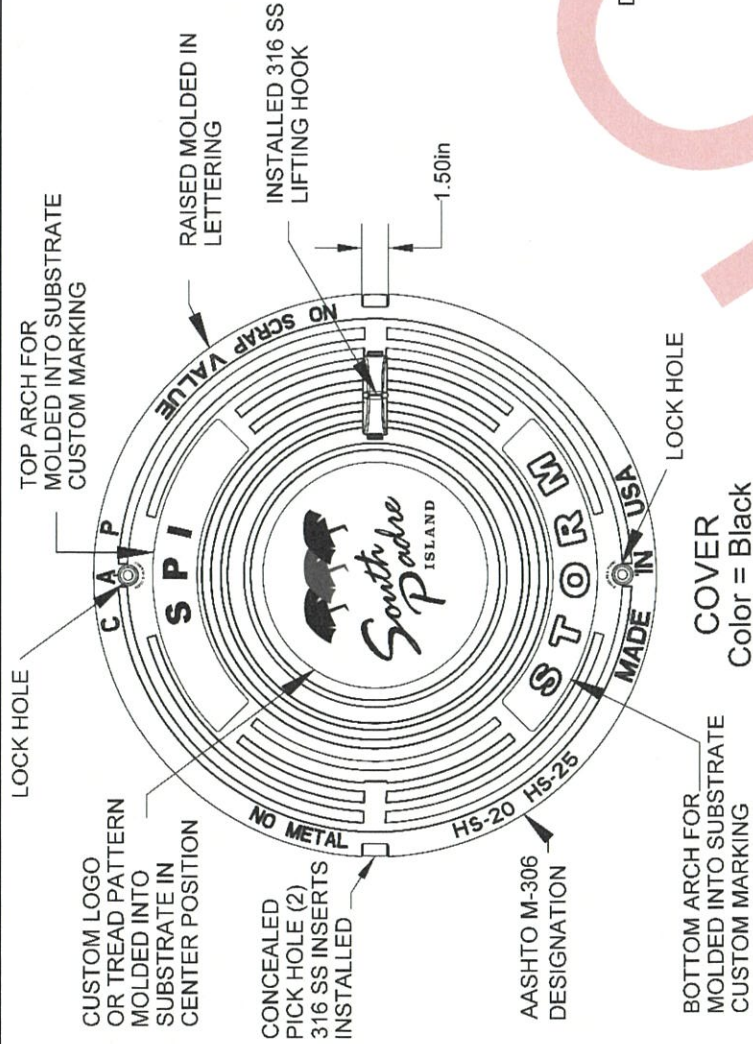

FRAME
 Color = Black

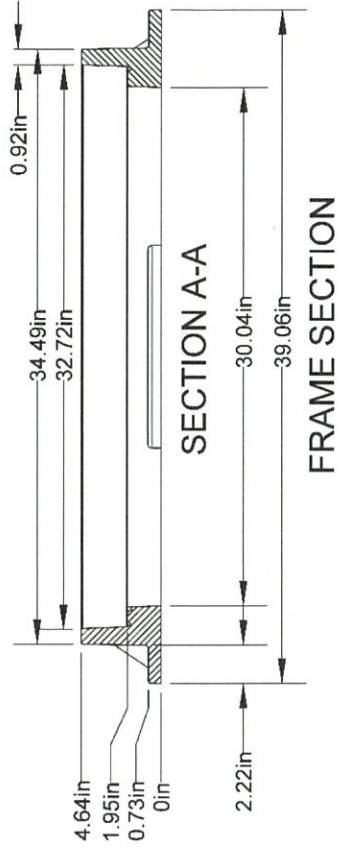

1. All hardware is 316 Stainless Steel.
2. Detectable by standard metal detectors.
3. Compression Molded Thermoset Composite - no metal reinforcement
4. PASSED M306 H20/H25 PROOF LOAD

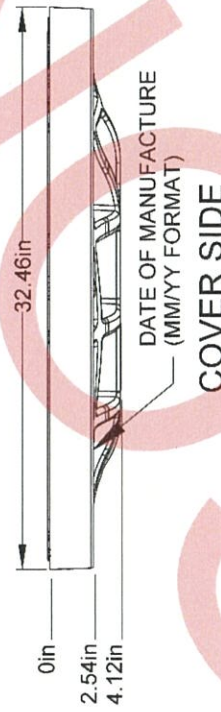

HOLE TO BOLT CLEARANCES PADDLE LOCK FEATURE



COMPOSITE ACCESS PRODUCTS L.P. "JUST CAP THAT"
 5216 N. 26TH STREET
 MCALLEN, TX 78504
 WEBSITE: www.justcapthat.com
 (844) 344-CAP1 (2271)

MODEL # **CAP ONE**

Product Code **A-1BK30P2-S09SPIST-H1** 2021-10-15

APPROVED BY: *[Signature]*
 DATE: 10-26-2021

CAD DWG. REF: 2000-103.DWG- 0

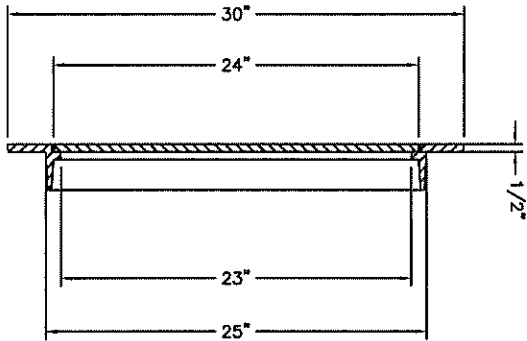
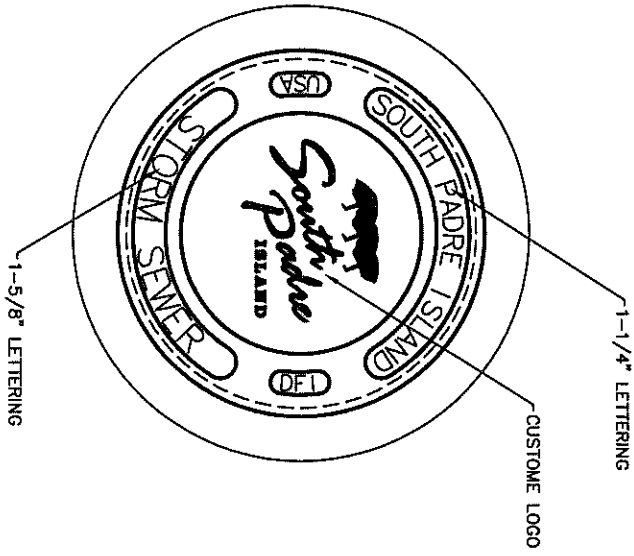

- NOTES:
- ALL DIMENSIONS SHOWN ARE IN ENGLISH
 - LOAD RATING: LIGHT DUTY
 - EQUIPMENT NOS: D55550972 K55550078
 - MATERIAL: CAST GRAY IRON ASTM A-48, CLASS 35B
 - FINISH: NO PAINT
 - WEIGHT: #68#

DATE	06-14-2019
APP.	JJF
CHK.	
DR.	
SCALE	1/8"=1"
TITLE	DF-2000 LID
PROJECT	NF-2000-103
ISSUE	
REV	
BY	
DATE	

DR.	HSJ	SCALE	1/8"=1"	TITLE	DF-2000 LID
CHK.	HG				
APP.	JJF				
DATE	06-14-2019				
 NEENAH FOUNDRY NEENAH, WISCONSIN 54956 PHONE 920-338-7575 LINCOLN, MICHIGAN 48828 PHONE 800-331-7488					
www.nfc.com					
NF-2000-103					
B					